

目 录

一、注意事项	1
1.1 安全信息的标志和定义	1
1.2 注意事项	1
1.3 保养与维护	2
1.4 报废注意事项	2
二、产品简介	3
2.1 变频器铭牌说明	3
2.2 变频器型号说明	3
2.3 三相变频器系列机型	4
2.4 技术规范	5
三、安装接线	6
3.1 变频器的安装	6
3.2 标准接线图	6
3.3 主回路端子和说明	7
3.4 控制端子及说明	8
四、操作运行	10
4.1 面板结构说明	10
4.2 按键说明	10
4.3 参数设置	11
4.4 LED 显示说明	11
4.5 状态指示灯说明	11
4.6 电机参数自学习	12
4.7 变频器的各种状态	12
五、功能参数说明	14
5.1 功能速查表	14
5.2 参数详解	26
六、选件 / 附件	57

七、故障检查与排除	62
7.1 故障信息及排除方法	62
7.2 常见故障及其处理方法	64
八、通讯协议	65
8.1 协议内容	65
8.2 应用方式	65
8.3 总线结构	65
8.4 协议说明	65
8.5 通讯帧结构	66
8.6 命令码及通讯数据描述	68

Table of Content

I. Important Information	77
1.1. Logo and Definition of Safety Information	77
1.2. Notice	77
1.3. Servicing and Maintenance.....	78
1.4. Scrap Notice.....	78
II. Product Overview	79
2.1. Name Description of Converter	79
2.2. Type Description of Converter.....	79
2.3. Three-Phase Inverter Series Models	79
2.4. Technical Specification	80
III. Installation Wiring	82
3.1. Installation of Converter.....	82
3.2. Standard Wiring Diagram.....	82
3.3. Main Circuit Terminal and Description	83
3.4. Control Terminal Description	84
IV. Operation	86
4.1. Panel Structure Description.....	86
4.2. Keys Description	86
4.3. Parameter Setting.....	87
4.4. LED Display Description.....	88
4.5. Status Indicator Description	88
4.6. Various Status of Converter.....	89
V. Function Parameter Description.....	90
5.1. Function Check Table:.....	90
5.2. Parameters Specification.....	107
5.2.3. H2 Motor Parameters Area.....	116
VI . Options/Accessories	149

VII. Fault Inspection and Troubleshooting	155
7.1 Fault information and Troubleshooting	155
7.2 Common faults and handling	158
VIII . Communication Protocol	159
8.1 Protocol content	159
8.2 Application mode	159
8.3 Bus structure	159
8.4 Protocol specification	160
8.5 Communication frame structure	160
8.6 Description of command code and communication data	163

一、注意事项

1.1 安全信息的标志和定义

本手册有三种标志定义，请在完全熟悉下面的图标和意义，并务必遵守所标明的注意事项，然后继续阅读本手册。



危险

表示没有按要求操作可能造成死亡和重伤事故。



禁止

表示绝对不可以做的事情。



注意

表示在操作使用过程中需要注意的事项。

1.2 注意事项



注意

- 安装使用环境无雨淋、水滴、蒸汽、粉尘及油性灰尘；无腐蚀、易燃性气体、液体；无金属微粒或金属粉末等。
- 变频器装在控制柜内，应保证控制柜与外界通风流畅。
- 勿将异物掉入变频器内。
- 接地应可靠，电机与变频器分别接地，切不可串联接地。
- 控制回路配线应与功率回路配线分开，以避免可能引起的干扰。
- 信号线不宜过长，否则会增加共模干扰
- 断电后 5 分钟内，请勿触摸内部器件。待完全放电后，方才安全。
- 符合表 2-2 对周围环境要求。



禁止

- 严禁将交流电源接到输出端子 U、V、W 上，否则将会造成变频器的损坏。
- 变频器运行中请勿在输出端切换负载。
- 切勿碰触变频器内高压端子，以防导致电击。
- 严禁带电作业。
- 变频器加电前要重新装好所有保护盖，以防电击。
- 只允许专业人员进行维护，检查或更换零部件。

1.3 保养与维护



注意

- 应定期清洁冷却风扇，并检查是否正常；定期清洁机内积存的灰尘。
- 应定期检查变频器的输入输出接线。
- 检查各端子接线螺钉是否紧固。检查电线是否老化。

1.4 报废注意事项



危险

- 变频器的内部电解电容焚烧时可能发生爆炸。
- 各种线路板在焚烧时会产生有毒气体



注意

- 应将变频器作为工业废品进行处理。

二、产品简介

2.1 变频器铭牌说明

在变频器的右侧下方,贴有表示变频器型号及额定值的铭牌,铭牌内容如图 2-1 所示:



图 2-1

2.2 变频器型号说明

变频器的型号说明如图 2-2 所示:

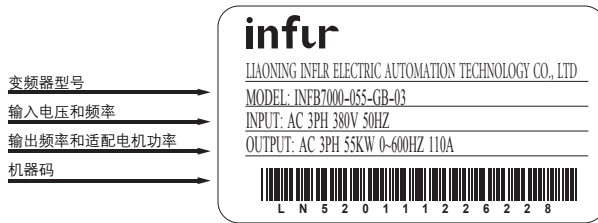

图 2-2

2.3 三相变频器系列机型

表 2-1

变频器型号	适用电机 (KW)	额定电流 (A)
INFB7000-R75-GB-3	0.75KW	2.5A
INFB7000-1R5-GB-3	1.5KW	3.7A
INFB7000-2R2-GB-3	2.2KW	6.0A
INFB7000-3R7-GB-3	3.7KW	9.0A
INFB7000-5R5-GB-3	5.5KW	13A
INFB7000-7R5-GB-3	7.5KW	17A
INFB7000-011-GB-3	11KW	25A
INFB7000-015-GB-3	15KW	32A
INFB7000-018-GB-3	18.5KW	37A
INFB7000-022-G-3	22KW	45A
INFB7000-030-G-3	30KW	60A
INFB7000-037-G-3	37KW	75A
INFB7000-045-G-3	45KW	90A
INFB7000-055-G-3	55KW	110A
INFB7000-075-G-3	75KW	150A
INFB7000-090-G-3	90KW	170A
INFB7000-110-G-3	110KW	210A
INFB7000-132-G-3	132KW	250A
INFB7000-160-G-3	160KW	300A
INFB7000-185-G-3	185KW	340A
INFB7000-200-G-3	200KW	380A
INFB7000-220-G-3	220KW	420A
INFB7000-250-G-3	250KW	480A
INFB7000-280-G-3	280KW	540A
INFB7000-315-G-3	315KW	610A
INFB7000-350-G-3	350KW	680A
INFB7000-380-G-3	380KW	730A
INFB7000-400-G-3	400KW	800A

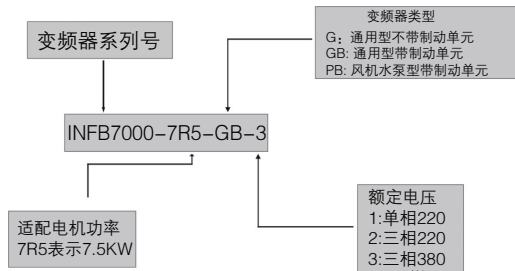
2.4 技术规范

表 2-2

	项目	规范
输入	额定电压	380±15% V
	额定频率	50/60Hz
输出	输出电压	0 ~ 380V
	输出频率	0.00 ~ 600.00Hz
	载波频率	0.5 ~ 15KHz
控制运行	控制方式	V/F 控制、无感矢量控制、转矩控制
	启动转矩	0.50 Hz 时 150% 额定转矩
	频率分辨率	数字设定 0.01Hz, 模拟量设定 0.1 Hz
	加减速	0.1 ~ 3600.0 秒任意设定
	过载能力	150% 额定电流, 60 秒
	启停控制	键盘启停控制、外控端子控制、上位机控制
保护	标准保护	过流、过压、过载、欠压、过热、失速、输入输出缺相保护
	指示灯	运行、正反转、电压、电流、频率指示
显示	LED 显示	显示运行频率、电压、电流、转速、故障代码、参数、功能码
	通讯接口	RS-485 标准内置
使用环境	安装场所	室内, 无腐蚀性气体、可燃气体、灰尘, 无阳光直射
	海拔高度	不高于 1000 米
	环境温度	-10℃ ~ +50℃
	环境湿度	90% 以下, 无水滴凝结现象
	振动强度	小于 0.5g

三、安装接线

3.1 变频器的安装

INFB7000 有壁挂式和落地式两种，安装应保证足够的通风距离，如图 3-1 所示：



图 3-1

3.2 标准接线图

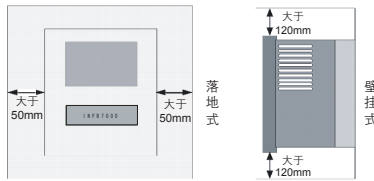

图 3-2

(适用于 18.5kW 以下机型)

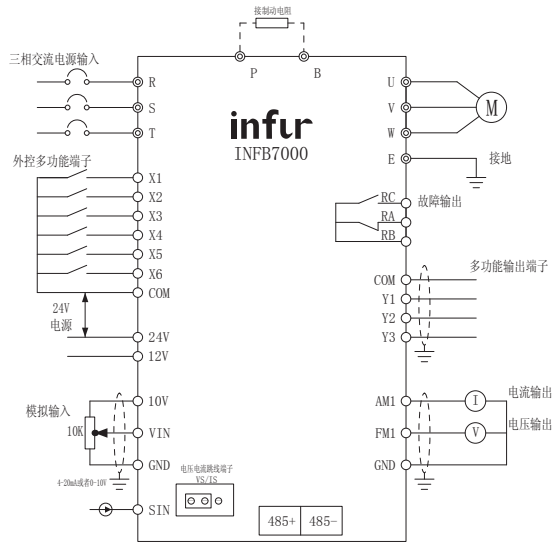

图 3-3

(适用于 22KW 以上机型)

3.3 主回路端子和说明

3.3.1 主回路端子示意图：

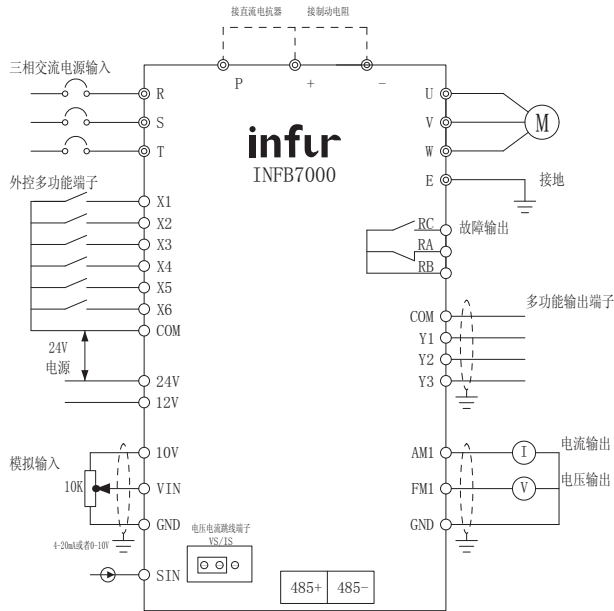
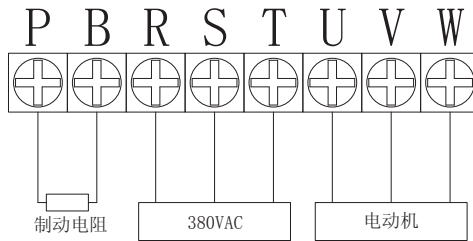

(适用于 2.2KW 以下)

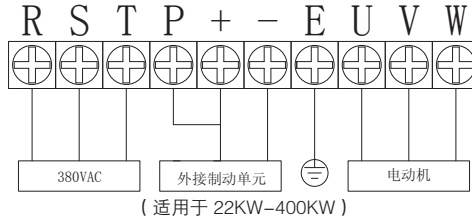
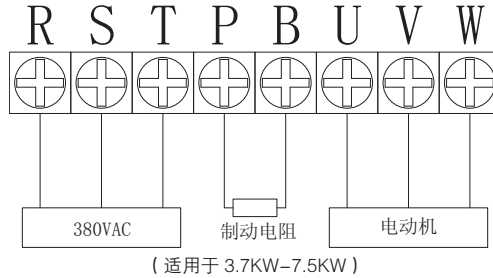

3.3.2 主回路端子功能说明

表 3-1

端子标号	端子名称	功能说明
R、S、T	变频器电源输入端子	接三相交流电源
+ (P)	外接制动单元	+ (P) 外接支流主回路的正极
- (N)		- (N) 外接支流主回路的负极
+、B	外接制动电阻	接制动电阻两端
P、+	外接直流电抗器端子	接制动电抗器两端
U、V、W	变频器出端子	接三相交流电机

3.4 控制端子及说明

3.4.1 端子分布如图 3-3 所示：



图 3-4

3.4.2 控制端子功能说明：

类型	端子标号	端子名称	功能说明
485 通讯	485+	RS485 收发的正端	RS-485 串行通讯，用来实现与其它 监控设备的连接。
	485-	RS485 收发的负端	
模拟 输入	SIN	模拟量输入端子	0 ~ 10V / 4 ~ 20 毫安 (mA)
	VIN	模拟量输入端子	0 ~ 10V
	GND	模拟量电源地	模拟输入和输出的公共地。
	10V	模拟量的电源	变频器内部提供的 10V 电源信号
可编程多功 能输入端子	X1	多功能输入端子	用户可定义的多功能端子，其 公共端为 COM，可通过功能码 H5.00 ~ H5.05 设置功能
	X2		
	X3		
	X4		
	X5		
	X6		
输出 信号	Y1	多功能输出端子	用户根据需要定义 Y1.Y2.Y3 的功 能，其功能通过 H6.00 ~ H6.02 来 设置
	Y2		
	Y3		
	COM	电源地	12V / 24V 的电源地
	RA	故障继电器	故障时 RB 和 RC 闭合，RB 和 RA 断开，如图 3-2 所示
	RB		
	RC		
	24V	继电器和 Y 端子的 电源	变频器内部提供的 24V 电源信号
	12V	12V 电源	变频器内部提供的 12V 电源信号
	AM1	模拟量输出信号	AM (FM) 和 GND 之间可以输出 0 ~ 10V 的电压信号
FM1			

四、操作运行

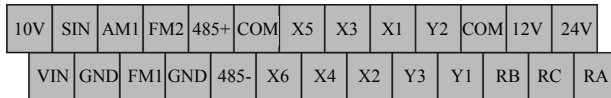
4.1 面板结构说明，如下图 4-1 所示



图 4-1

4.2 按键说明，见表 4-1

表 4-1

按键	按键名称	说明
RUN	运行	按下该键马上运行
STOP RST	停机 / 复位	按下该键马上停机
JOG	点动	按着不放，点动运行，放开回到点动前状态
SET	设定	在功能码编辑状态，按下设定键，进入参数编辑状态，再按设定键，保存调整后的参数返回功能码编辑状态
PROG	编程	按下编程键，进入功能码编辑状态，再次按下编程键，返回上次状态
▲	上升	在参数和功能码编辑时，用于被选中位数据的递增，在运行的过程中，在显示频率状态下，用于频率的递增
▼	下降	在参数和功能码编辑时，用于被选中位数据的递减，在运行的过程中，在显示频率状态下，用于频率的递减
←	移位	在参数和功能码编辑时，用来选择数据位，还可以循环查看运行过程中的状态

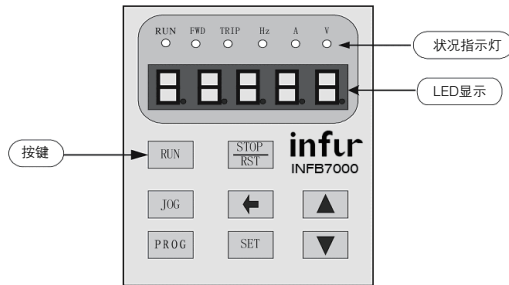
4.3 参数设置

本变频器的参数设置过程如图 4-2 所示



图 4-2

具体操作流程为：按下 **PROG**，进入功能码编辑状态，然后通过按下 **←**、**▲**、**▼** 选择分区和区内码（被选中的位闪烁），然后按下 **SET**，进入参数编辑状态，并显示当前参数值，接着通过 **←**、**▲**、**▼** 修改参数（被选中的位闪烁，若参数没有闪烁位，表示该功能码不能修改），修改完毕，按下 **SET**，保存修改后的参数到变频器内，自动返回到功能码编辑状态，如果需要修改多个参数，重复上面的操作即可，如果要返回到当前状态，在参数编辑状态下，按下 **PROG** 即可返回。

4.4 LED 显示说明

5 位 LED 显示，可显示设定频率、输出频率等各种监视数据以及报警代码

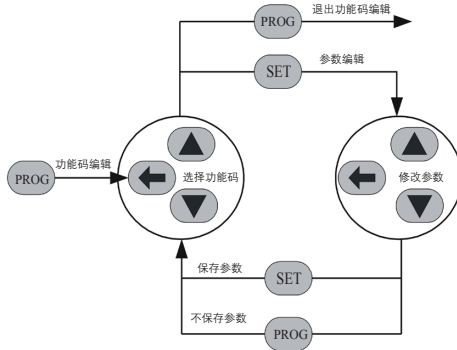
4.5 状态指示灯说明

RUN	运行指示灯，运行时亮，停机时灭
FWD	正反转指示灯，正转时亮，反转时灭
TRIP	保留
Hz	频率单位
A	电流单位
V	电压单位

4.6 电机参数自学习

选择无 PG 矢量控制运行方式，在变频器运行前，必须准确输入电机的铭牌参数，INFB7000 系列变频器据此铭牌参数匹配标准电机参数；矢量控制方式对电机参数依赖性很强，要获得良好的控制性能，必须获得被控电机的准确参数。

电机参数自学习操作步骤如下：

首先将运行指令通道选择（H0.01）选择为键盘指令通道。

然后请按电机实际参数输入下面：

H2.01：电机额定功率；H2.02：电机额定频率；H2.03：电机额定转速；H2.04：电机额定电压；

H2.05：电机额定电流。

注意：电机要和负载脱开，否则，自学习得到的电机参数可能不正确。设置 H0.12 为 1，详细电机参数自学习过程请参考功能码 H0.12 的说明。然后按键盘面板上 **RUN** 键，变频器会自动计算出电机的下列参数：

H2.06：电机定子电阻；H2.07：电机转子电阻；H2.08：电机定、转子电感；

H2.09：电机定、转子互感；

H2.10：电机空载电流；完成电机参数自学习。

4.7 变频器的各种状态

4.7.1 上电初始化状态

变频器上电过程，系统首先进行初始化，LED 显示为“H7000”。等初始化完成以后，变频器处于待机状态。

4.7.2 停机状态

在停机或运行状态下，可显示多种状态参数。可由功能码 H7.06(运行参数)、H7.07(停机参数)按二进制的位选择该参数是否显示，各位定义见 H7.06 和 H7.07 功能码的说明。

在停机状态下，共有九个停机状态参数可以选择是否显示，分别为：设定频率、母线电压、开关量输入状态、集电极开路输出状态、PID 设定、PID 反馈、模拟输入 VIN 电压、模拟输入 SIN 电压、多段速段数，是否显示由功能码 H7.07 按位（转化为二进制）选择，按  键顺序切换显示选中的参数。

4.7.3 电机参数自学习状态

详情请参考功能码 H0.12 的详细说明。

4.7.4 运行状态

在运行状态下，共有十四个状态参数可以选择是否显示，分别为：运行频率、设定频率、母线电压、输出电压、输出电流、输出功率、输出转矩、PID 设定、PID 反馈、开关量输入状态、集电极开路输出状态、模拟输入 VIN 电压、模拟输入 SIN 电压、多段速段数，是否显示由功能码 H7.06 按位（转化为二进制）选择，按  键顺序切换显示选中的参数。

4.7.5 故障状态

INFB7000 系列变频器提供多种故障信息，详情请参考 INFB7000 系列变频器故障及其对策。

五、功能参数说明

5.1 功能速查表

表 5-1

功能码	功能说明	设置范围和说明	单位	出厂值	修改
H0 组基本参数区					
H0.00	控制模式选择	0: 无速度传感器矢量控制 1: V/F 控制 2: 转矩控制	无	0	×
H0.01	起停信号选择	0: 键盘起停 1: 端子起停 2: 通讯控制起停	无	0	×
H0.02	键盘及端子上升下降设定	0: 有效, 且变频器掉电存储 1: 有效, 且变频器掉电不存储 2: 无效 3: 运行时设置有效, 停机清零	无	0	√
H0.03	频率设定选择	0: 键盘设定 1: 模拟量 VIN 设定 2: 模拟量 SIN 设定 3: VIN+ SIN 4: 多段速运行设定 5: PID 控制设定 6: 远程通讯设定	无	0	√
H0.04	最大输出频率	10.00 ~ 600.00Hz	赫兹	50.00Hz	×
H0.05	运行频率上限	H0.06 ~ H0.04	赫兹	50.00Hz	√
H0.06	运行频率下限	0.00Hz ~ H0.05	赫兹	0.00	√
H0.07	键盘设定频率	0.00 Hz ~ H0.04	赫兹	50.00Hz	√
H0.08	加速时间	0.1 ~ 3600.0s	秒	10.0s	√
H0.09	减速时间	0.1 ~ 3600.0s	秒	10.0s	√
H0.10	运行方向选择	0: 正向运行 1: 反向运行 2: 禁止反转运行	无	0	×
H0.11	载波频率设定	0.5 ~ 15.0kHz	千赫兹	8.0 kHz	√

五、功能参数说明 P15

H0.12	电机参数辨识	0: 无操作 1: 电机参数辨识 2: 参数静止自学习	无	0	×
H0.13	是否恢复缺省值	0: 无操作 1: 恢复缺省值	无	0	×
H0.14	AVR 功能选择	0: 无效 1: 全程有效 2: 只在减速时无效	无	0	√
H1 组起停控制参数区					
H1.00	起动运行方式选择	0: 直接起动 1: 先直流制动再起动 2: 转速跟踪再启动	无	0	×
H1.01	直接起动开始频率	0.00 ~ 10.00Hz	赫兹	0.00Hz	√
H1.02	起动频率保持时间	0.0 ~ 50.0s	秒	0.0	√
H1.03	起动前制动电流	0.0 ~ 150.0%	%	0.0%	√
H1.04	起动前制动时间	0.0 ~ 50.0s	秒	0.0s	√
H1.05	停机方式选择	0: 减速停车 1: 自由停车	无	0	√
H1.06	停机制动开始频率	0.00 ~ H0.04	赫兹	0.00Hz	√
H1.07	停机制动等待时间	0.0 ~ 50.0s	秒	0.0s	√
H1.08	停机直流制动电流	0.0 ~ 150.0	%	0.0	√
H1.09	停机直流制动时间	0.0 ~ 50.0s	秒	0.0s	√
H1.10	正反转死区时间	0.0 ~ 3600.0s	秒	0.0s	√
H1.11	上电端子运行保护选择	0: 上电时端子运行命令无效 1: 上电时端子运行命令有效	无	0	√
H1.12	保留				
H2 组电机参数区					
H2.00	变频器类型	0: G 型机	无	0	×
H2.01	电机额定功率	0.4 ~ 900.0kW	千瓦	机型设定	×
H2.02	电机额定频率	0.01Hz ~ H0.04	赫兹	50.00Hz	×

P16 五、功能参数说明

H2.03	电机额定转速	0 ~ 36000rpm	转 / 分钟	1400	×
H2.04	电机额定电压	0 ~ 460V	伏特	380	×
H2.05	电机额定电流	0.1 ~ 2000.0A	安培	机型设定	×
H2.06	电机定子电阻	0.001 ~ 65.535 Ω	欧姆	机型设定	√
H2.07	电机转子电阻	0.001 ~ 65.535 Ω	欧姆	机型设定	√
H2.08	电机定、转子电感	0.1 ~ 6553.5mH	毫亨	机型设定	√
H2.09	电机定、转子互感	0.1 ~ 6553.5mH	毫亨	机型设定	√
H2.10	电机空载电流	0.01 ~ 655.35A	安培	机型设定	√
H3 组矢量控制组					
H3.00	速度环比例增益 1	0 ~ 100	无	20	√
H3.01	速度环积分时间 1	0.01 ~ 10.00s	秒	0.50s	√
H3.02	切换低点频率	0.00Hz ~ H3.05	赫兹	5.00Hz	√
H3.03	速度环比例增益 2	0 ~ 100	无	25	√
H3.04	速度环积分时间 2	0.01 ~ 10.00s	秒	1.00	√
H3.05	切换高点频率	H3.02 ~ H3.04	赫兹	10.00Hz	√
H3.06	VC 转差补偿系数	50 ~ 200%	%	100%	√
H3.07	转矩上限设定	0.0 ~ 200.0% (变频器额定电流)	%	150%	√
H4 组 V/F 控制组					
H4.00	V/F 曲线设定	0: 直线 V/F 曲线 1: 2.0 次幂降转矩 V/F 曲线	无	0	×
H4.01	转矩提升	0.0: (自动) 0.1 ~ 30.0	%	0.0%	√
H4.02	转矩提升截止	0.0 ~ 50.0% 相对电机额定频率)	%	20.0%	×
H4.03	V/F 转差补偿限定	0.0 ~ 200.0%	%	100.0%	√
H4.04	节能运行选择	0: 不动作 1: 自动节能运行	无	0	√

H5 组输入端子组					
H5.00	X1 端子功能选择	0: 无功能 1: 正转运行 2: 反转运行 3: 三线式运行控制	无	1	×
H5.01	X2 端子功能选择	4: 正转寸动 5: 反转寸动 6: 自由停车 7: 故障复位 8: 外部故障输入	无	4	×
H5.02	X3 端子功能选择	9: 频率设定递增 (UP) 10: 频率设定递减 (DOWN) 11: 频率增减设定清除	无	7	×
H5.03	X4 端子功能选择	12: 多段速端子 1 13: 多段速端子 2 14: 多段速端子 3 15: 加减速时间选择	无	0	×
H5.04	X5 端子功能选择	16: PID 控制暂停 17: 摆频暂停 (停在当前频率) 18: 摆频复位 (回到中心频率)	无	0	×
H5.05	X6 端子功能选择	19: 加减速禁止 20: 转矩控制禁止 21: 频率增减设定暂时清除 22 ~ 25: 保留	无	0	×
H5.06	开关量滤波次数	1 ~ 10	无	5	√
H5.07	端子控制运行模式	0: 两线式控制 1 1: 两线式控制 2 2: 三线式控制 1 3: 三线式控制 2	无	0	×
H5.08	端子上升下降频率增量变化率	0.01 ~ 50.00Hz/s	赫兹 / 秒	0.50Hz/s	√
H5.09	VIN 下限值	0.00V ~ 10.00V	伏特	0.00V	√
H5.10	VIN 下限对应设定	-100.0 ~ 100.0%	%	0.0%	√
H5.11	VIN 上限值	0.00V ~ 10.00V	伏特	10.00V	√
H5.12	VIN 上限对应设定	-100.0 ~ 100.0%	%	100.0%	√
H5.13	VIN 输入滤波时间	0.00s ~ 10.00s	秒	0.10s	√

P18 五、功能参数说明

H5.14	SIN 下限值	0.00V ~ 10.00V	伏特	0.00V	√
H5.15	SIN 下限对应设定	-100.0 ~ 100.0%	%	0.0%	√
H5.16	SIN 上限值	0.00V ~ 10.00V	伏特	10.00V	√
H5.17	SIN 上限对应设定	-100.0 ~ 100.0%	%	100.0%	√
H5.18	SIN 输入滤波时间	0.00s ~ 10.00s	秒	0.10s	√
H6 组输出端子组					
H6.00	Y1 输出选择	0: 无输出 1: 电机正转运行中 2: 电机反转运行中 3: 故障输出 4: 频率水平检测 FDT 输出 5: 频率到达 6: 零速运行中 7: 上限频率到达 8: 下限频率到达 9 ~ 10: 保留	无	1	√
H6.01	Y2 输出选择		无	0	
H6.02	Y3 输出选择		无	0	√
H6.03	继电器输出选择		无	3	
H6.04	FM(AM) 输出选择	0: 运行频率 1: 设定频率 2: 运行转速 3: 输出电流 4: 输出电压 5: 输出功率 6: 输出转矩 7: 模拟 VIN 输入值 8: 模拟 SIN 输入值 9 ~ 10: 保留	无	0	√
H6.05	FM(AM) 输出下限	0.0 ~ 100.0%	%	0.0%	√
H6.06	下限对应 FM(AM) 输出	0.00V ~ 10.00V	伏特	0.00V	√
H6.07	FM(AM) 输出上限	0.0 ~ 100.0%	%	100.0%	√
H6.08	上限对应 FM 输出	0.00V ~ 10.00V	伏特	10.00V	√
H7 组人机界面组					
H7.00	用户密码	0 ~ 65535	无	0	√
H7.01	保留				

H7.02	保留				
H7.03	QUICK/IOG 键功能选择	0: 寸动运行 1: 正转反转切换 2: 清除 UP/DOWN 设定	无	0	×
H7.04	STOP/RST 键 停机功能选择	0: 只对操作面板控制有效 1: 对操作面板和端子控制同时有效 2: 对面板和通讯控制同时有效 3: 所有控制模式都有效	无	0	√
H7.05	键盘显示选择	0: 外引键盘优先显示 1: 本机、外引键盘同时显示, 只外引按键有效 2: 本机、外引键盘同时显示, 只本机按键有效	无	0	√
H7.06	运行状态显示的 参数选择	0 ~ 0x7FFF FE: 运行频率 Fd: 设定频率 FC: 母线电压 Fb: 输出电压 FA: 输出电流 F9: 运行转速 F8: 输出功率 F7: 输出转矩 F6: PID 给定值 F5: PID 反馈值 F4: 输入端子状态 F3: 输出端子状态 F2: 模拟量 VS1 值 F1: 模拟量 SIN 值 F0: 多段速当前段数	无	0xFF	√
H7.07	停机状态显示的 参数选择	1 ~ 0x1FFF FE: 设定频率 Fd: 母线电压 FC: 输入端子状态 Fb: 输出端子状态 FA: PID 给定值 F9: PID 反馈值 F8: 模拟量 VIN 值 F7: 模拟量 SIN 值 F6: 多段速当前段数 F5 ~ F0: 保留	无	0xFF	√
H7.08	整流模块温度	0 ~ 100.0℃	度		
H7.09	逆变模块温度	0 ~ 100.0℃	度		

P20 五、功能参数说明

H7.10	软件版本		无	3.0	
H7.11	本机累积运行时间	0 ~ 65535h	小时	0	
H7.12	前两次故障类型	0: 无故障 1: 逆变单元 U 相保护 (E001) 2: 逆变单元 V 相保护 (E002) 3: 逆变单元 W 相保护 (E003) 4: 加速过电流 (E004) 5: 减速过电流 (E005) 6: 恒速过电流 (E006) 7: 加速过电压 (E007) 8: 减速过电压 (E008) 9: 恒速过电压 (E009)	无		
H7.13	前一次故障类型	10: 母线欠压故障 (E010) 11: 电机过载 (E011) 12: 变频器过载 (E012) 13: 输入侧缺相 (E013) 14: 输出侧缺相 (E014) 15: 整流块过热 (E015) 16: 逆变模块过热故障 (E016) 17: 外部故障 (E017)	无		
H7.14	当前故障类型	18: 通讯故障 (E018) 19: 电流检测故障 (E019) 20: 电机自学习故障 (E020) 21: EEPROM 操作故障 (E021) 22: PID 反馈断线故障 (E022) 23: 制动单元故障 (E023) 24: 保留	无		
H7.15	当前故障运行频率		赫兹		
H7.16	当前故障输出电流		安培	0.0A	
H7.17	当前故障母线电压		伏特	0.0V	
H7.18	当前故障输入端子状态		无	0	

五、功能参数说明 P21

H7.19	当前故障输出端子状态		无	0	√
H8 组增强参数区					
H8.00	加速时间 2	0.1 ~ 3600.0s	秒	20.00s	√
H8.01	减速时间 2	0.1 ~ 3600.0s	秒	20.00s	√
H8.02	点动运行频率	0.00 ~ H0.04	赫兹	5.00Hz	√
H8.03	点动运行加速时间	0.1 ~ 3600.0s	秒	20.00s	√
H8.04	点动运行减速时间	0.1 ~ 3600.0s	秒	20.00s	√
H8.05	跳跃频率	0.00 ~ H0.04	赫兹	0.00Hz	√
H8.06	跳跃频率幅度	0.00 ~ H0.04	赫兹	0.00Hz	√
H8.07	摆频幅度	0.0 ~ 100.0% (相对设定频率)	%	0.0%	√
H8.08	突跳频率幅度	0.0 ~ 50.0% (相对摆频幅度)	%	0.0%	√
H8.09	摆频上升时间	0.1 ~ 3600.0s	秒	5.0s	√
H8.10	摆频下降时间	0.1 ~ 3600.0s	秒	5.0s	√
H8.11	故障自动复位次数	0 ~ 3	无	0	√
H8.12	故障自动复位间隔时间设置	0.1 ~ 100.0s	秒	1.0s	√
H8.13	FDT 电平检测值	0.00 ~ H0.04	赫兹	50.00Hz	√
H8.14	FDT 滞后检测值	0.0 ~ 100.0% (FDT 电平)	%	5.0%	√
H8.15	频率到达检出幅度	0.0 ~ 100.0% (最大频率)	%	0.0%	√
H8.16	制动阈值电压	115.0 ~ 140.0% (标准母线电压)	%	125.0%	√
H8.17	转速显示系数	0.1 ~ 999.9% 机械转速 = 120 * 运行频率 * H8.17 / 电机极对数	%	100.0%	√
H9 组 PID 参数区					

H9.00	PID 给定源选择	0: 键盘给定 1: 模拟通道 VIN 给定 2: 模拟通道 SIN 给定 3: 远程通讯给定 4: 多段给定	无	0	√
H9.01	键盘预置 PID 给定	0.0% ~ 100.0%	%	0.0%	×
H9.02	PID 反馈源选择	0: 模拟通道 VIN 反馈 1: 模拟通道 SIN 反馈 2: VIN+SIN 反馈 3: 远程通讯反馈	无	0	√
H9.03	PID 输出特性选择	0: PID 输出为正特性 1: PID 输出为负特性	无	0	√
H9.04	比例增益 (Kp)	0.00 ~ 100.00	无	1.00	√
H9.05	积分时间 (Ti)	0.01 ~ 10.00s	秒	0.10s	√
H9.06	微分时间 (Td)	0.00 ~ 10.00s	秒	0.00s	√
H9.07	采样周期 (T)	0.01 ~ 100.00s	秒	0.10s	√
H9.08	PID 控制偏差极限	0.0 ~ 100.0%	%	0.0%	√
H9.09	反馈断线检测值	0.0 ~ 100.0%	%	0.0%	√
H9.10	反馈断线检测时间	0.0 ~ 3600.0s	秒	1.0s	√
HA 组多段速参数区					
Ha.00	多段速 0	-100.0 ~ 100.0%	%	0.0%	√
Ha.01	多段速 1	-100.0 ~ 100.0%	%	0.0%	√
Ha.02	多段速 2	-100.0 ~ 100.0%	%	0.0%	√
Ha.03	多段速 3	-100.0 ~ 100.0%	%	0.0%	√
Ha.04	多段速 4	-100.0 ~ 100.0%	%	0.0%	√
Ha.05	多段速 5	-100.0 ~ 100.0%	%	0.0%	√
Ha.06	多段速 6	-100.0 ~ 100.0%	%	0.0%	√
Ha.07	多段速 7	-100.0 ~ 100.0%	%	0.0%	√
HB 组保护和故障参数区					

五、功能参数说明 P23

Hb.00	电机过载保护选择	0: 不保护 1: 普通电机 (带低速补偿) 2: 变频电机 (不带低速补偿)	无	1	×
Hb.01	电机过载保护电流	20.0% ~ 120.0% (电机额定电流)	%	100.0%	√
Hb.02	瞬间掉电降频点	70.0 ~ 110.0% (标准母线电压)	%	80.0%	√
Hb.03	瞬间掉电频率降率	0.00Hz ~ H0.04	赫兹	0.00Hz	√
Hb.04	过压失速保护	0: 禁止 1: 允许	无	0	√
Hb.05	过压失速保护电压	110 ~ 150%	%	120%	√
Hb.06	自动限流水平	100 ~ 200%	%	200%	√
Hb.07	限时频率下降率	0.00 ~ 100.00Hz/s	赫兹 / 秒	00.00Hz/s	√
HC 组 485 参数区					
Hc.00	本机通讯地址	1 ~ 247, 0 为广播地址	无	1	√
Hc.01	通讯波特率设置	0: 1200BPS 1: 2400BPS 2: 4800BPS 3: 9600BPS 4: 19200BPS 5: 38400BPS	无	3	√
Hc.02	数据位校验设置	0: 无校验 (N, 8, 1) For RTU 1: 偶校验 (E, 8, 1) for RTU 2: 奇校验 (O, 8, 1) for RTU 3: 无校验 (N, 8, 2) for RTU 4: 偶校验 (E, 8, 2) for RTU 5: 奇校验 (O, 8, 2) for RTU 6: 无校验 (N, 7, 1) for ASCII	无	0	√

		7: 偶校验 (E, 7, 1) for ASCII 8: 奇校验 (O, 7, 1) for ASCII 9: 无校验 (N, 7, 2) for ASCII 10: 偶校验 (E, 7, 2) for ASCII 11: 奇校验 (O, 7, 2) for ASCII 12: 无校验 (N, 8, 1) for ASCII 13: 偶校验 (E, 8, 1) for ASCII 14: 奇校验 (O, 8, 1) for ASCII 15: 无校验 (N, 8, 2) for ASCII 16: 偶校验 (E, 8, 2) for ASCII 17: 奇校验 (O, 8, 2) for ASCII			
Hc.03	通讯应答延时	0 ~ 200ms	毫秒	5ms	√
Hc.04	通讯超时故障时间	0.0 (无效), 0.1 ~ 100.0s	秒	0.0s	√
Hc.05	传输错误处理	0: 报警并自由停车 1: 不报警并继续运行 2: 不报警按停机方式停机 (仅通讯控制方式下) 3: 不报警按停机方式停机 (所有控制方式下)	无	1	√
Hc.06	传输回应处理	0: 写操作有回应 1: 写操作无回应	无	0	√
HD 组补充参数区					
Hd.00	抑制振荡 低频阀值点	0 ~ 500	无	5	√
Hd.01	抑制振荡 高频阀值点	0 ~ 500	无	100	√
Hd.02	抑制振荡限幅值	0 ~ 10000	无	5000	√

Hd.03	抑制振荡高低频分界频率	0.00Hz ~ H0.04 (最大频率)	无	12.50Hz	√
Hd.04	抑制振荡	0: 抑制振荡有效 1: 抑制振荡无效	无	1	√
Hd.05	PWM 选择	0: PWM 模式 1 1: PWM 模式 2 2: PWM 模式 3	无	0	×
Hd.06	转矩设定方式选择	0: 键盘设定转矩 (Hd.07) (100% 相对于 H3.07 转矩上限) 1: 模拟量 VIN 设定转矩 (100% 相对于 H3.07 转矩上限) 2: 模拟量 SIN 设定转矩 (100% 相对于 H3.07 转矩上限) 3: 模拟量 VIN+SIN 设定转矩 (100% 相对于 H3.07 转矩上限) 4: 多段转矩设定 (100% 相对于 H3.07 转矩上限) 5: 远程通讯设定转矩 (100% 相对于 H3.07 转矩上限)	无	0	√
Hd.07	键盘设定转矩	-100.0% ~ 100.0%	无	0	√
Hd.08	上限频率设定源选择	0: 键盘设定上限频率 (H0.05) 1: 模拟量 VIN 设定上限频率 (100% 对应最大频率) 2: 模拟量 SIN 设定上限频率 (100% 对应最大频率) 3: 多段设定上限频率 (100% 对应最大频率) 4: 远程通讯设定上限频率 (100% 对应最大频率)	无	0	√
Hd.09	限流动作选择	0: 限流一直有效 1: 限流恒速时无效	无	0	√
HE 组厂家参数区					
HE.00	厂家密码	0 ~ 65535	无	0	√

5.2 参数详解

5.2.1 H0 基本参数组

H0.00	控制模式选择	0: 无速度传感器矢量控制 1: V/F 控制 2: 转矩控制	无	0	×
-------	--------	--	---	---	---

选择变频器的运行方式：

0: 无 PG 矢量控制

指开环矢量。适用于不装编码器 PG 的高性能通用场合，如机床、离心机、拉丝机、注塑机等负载。

一台变频器只能驱动一台电机。

1: V/F 控制

适用于对控制精度要求不高的场合，如风机、泵类负载。可用于一台变频器拖动多台电机的场合。

提示：选择矢量控制方式时，必须进行过电机参数自学习。只有得到准确的电机参数才能发挥矢量控制方式的优势。通过调整速度调节器参数可获得更优的性能。

2: 转矩控制

H0.01	起停信号选择	0: 键盘起停 1: 端子起停 2: 通讯控制起停	无	0	×
-------	--------	--	---	---	---

选择变频器的起停信号。

变频器控制命令包括：起动、停机、正转、反转、点动、故障复位等。

0: 键盘起停

由键盘面板上的 RUN、STOP/RST 按键进行运行命令控制。在运行状态下，如果同时按下 RUN 与 STOP/RST 键，即可使变频器自由停机。

1: 端子起停

由多功能输入端子正转、反转、正转点动、反转点动等进行运行命令控制。

2: 通讯指令通道

运行命令由上位机通过通讯方式进行控制。

H0.02	键盘及端子上升下降设定	0: 有效，且变频器掉电存储 1: 有效，且变频器掉电不存储 2: 无效 3: 运行时设置有效，停机清零	无	0	√
-------	-------------	---	---	---	---

变频器可以通过键盘的“^”和“v”以及端子 UP/DOWN（频率设定递增/频率设定递减）功能来设定频率，其权限最高，可以和其他任何频率设定通道进行组合。主要是完成在控制系统调试过程中微调变频器的输出频率。

0: 有效，且变频器掉电存储。可设定频率指令，并且，在变频器掉电以后，存储该

设定频率值，下次上电以后，自动与当前的设定频率进行组合。

1: 有效，且变频器掉电不存储。可设定频率指令，只是在变频器掉电后，该设定频率值不存储。

2: 无效，则键盘及端子 UP/DOWN 功能设定的频率值自动清零，并且，键盘及端子 UP/DOWN 设定无效。

3: 运行时设置“^”和“V”及端子 UP/DOWN 功能设定有效，停机时键盘的“^”和“V”及端子 UP/DOWN 设定清零。

注意：当用户对变频器进行恢复缺省值操作后，键盘及端子 UP/DOWN 功能设定的频率值自动清零。

H0.03	频率设定选择	0: 键盘设定 1: 模拟量 VIN 设定 2: 模拟量 SIN 设定 3: VIN+ SIN 4: 多段速运行设定 5: PID 控制设定 6: 远程通讯设定	无	0	√
-------	--------	---	---	---	---

选择变频器给定频率输入通道。共有 7 种主给定频率通道：

0: 键盘设定

通过修改功能码 H0.07 “键盘设定频率”的值，达到键盘设定频率的目的。

1: 模拟量 VIN 设定

2: 模拟量 SIN 设定

3: 模拟量 VIN+ SIN 设定

指频率由模拟量输入端子来设定。INFB7000 系列变频器标准配置提供 2 路模拟量输入端子，其中 VIN 为 0 ~ 10V 电压型输入，SIN 可为 0 ~ 10V 电压输入，也可为 0 (4) ~ 20mA 电流输入，电流、电压输入可通过跳线进行切换。

模拟输入设定的 100.0% 对应最大频率 (功能码 H0.04)，-100.0% 对应反向的大频率 (功能码 H0.04)。

4: 多段速运行设定

选择此种频率设定方式，变频器以多段速方式运行。需要设置 H5 组和 HA 组“多段速控制组”参数来确定给定的百分数和给定频率的对应关系。

5: PID 控制设定

选择此参数则变频器运行模式为过程 PID 控制。此时，需要设置 H9 组“PID 控制组”。变频器运行频率为 PID 作用后的频率值。其中 PID 给定源、给定量、反馈源等含义请参考 H9 组“PID 功能”介绍。

6: 远程通讯设定

频率指令由上位机通过通讯方式给定。详情请参考 485 通讯协议。

H0.04	最大输出频率	10.00 ~ 600.00Hz	赫兹	50.00Hz	×
-------	--------	------------------	----	---------	---

用来设定变频器的最高输出频率。它是频率设定的基础，也是加减速快慢的基础。

H0.05	运行频率上限	H0.06 ~ H0.04	赫兹	50.00Hz	√
-------	--------	---------------	----	---------	---

变频器输出频率的上限值。该值应该小于或者等于最大输出频率。

H0.06	运行频率下限	0.00Hz ~ H0.05	赫兹	0.00	√
-------	--------	----------------	----	------	---

变频器输出频率的下限值。当设定频率低于下限频率时以下限频率运行。

其中，最大输出频率 ≥ 上限频率 ≥ 下限频率

H0.07	键盘设定频率	0.00 Hz ~ H0.04	赫兹	50.00Hz	√
-------	--------	-----------------	----	---------	---

当频率给定选择为“键盘设定”时，该功能码值为变频器的频率数字设定初始值。

H0.08	加速时间	0.1 ~ 3600.0s	秒	10.0s	√
H0.09	减速时间	0.1 ~ 3600.0s	秒	10.0s	√

加速时间指变频器从 0Hz 加速到最大输出频率（H0.04）所需时间。

减速时间指变频器从最大输出频率（H0.04）减速到 0Hz 所需时间。

如下图示：



图 5-1 加减速时间示意图

当设定频率等于最大频率时，实际加速时间和设定的加减速时间一致。

当设定频率小于最大频率时，实际的加速时间小于设定的加减速时间。

实际的加减速时间 = 设定的加减速时间 × (设定频率 / 最高频率)

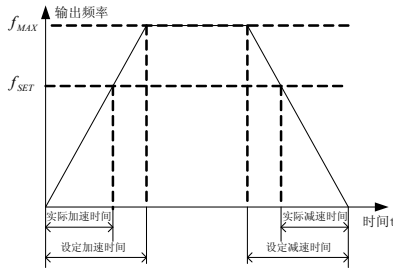
H0.10	运行方向选择	0: 正向运行 1: 反向运行 2: 禁止反转运行	无	0	×
-------	--------	---------------------------------	---	---	---

0：正向运行。变频器上电后，按照实际的方向运行。

1：反向运行。通过更改该功能码可以在不改变其他任何参数的情况下变电机的转向，其作用相当于通过调整电机线（U、V、W）任意两条线实现电旋转方向的转换。

提示：参数初始化后，电机运行方向会恢复原来的状态。对于系统调试好严禁更改电机转向的场合慎用。

2：禁止反转运行。禁止变频器反向运行，适合应用在特定的禁止反转运行场合。

H0.11	载波频率设定	1.0 ~ 15.0kHz	千赫兹	8.0 kHz	√
-------	--------	---------------	-----	---------	---

载波频率	电磁噪音	杂音、漏电流	热散逸
1KHz	↑ 大	↑ 小	↑ 小
10KHz			
15KHz	↓ 小	↓ 大	↓ 大

图 5-2 载频对环境的影响关系图

机型和载频的关系表

载波频率机型	最高载频kHz	最低载频kHz	出厂值kHz
0.75 ~ 15 kW	15	1	8
18.5 ~ 75 kW	8	1	4
90 ~ 400 kW	6	1	2

此功能主要用于改善电机运行的噪音以及变频器对外界的干扰等问题。

采用高载波频率的优点：电流波形比较理想、电流谐波少，电机噪音小；采用高载波频率的缺点：开关损耗增大，变频器温升增大，变频器的输出能力受到影响，在高载频下，变频器需降额使用；同时变频器的漏电流增大，对外界的电磁干扰增加。采用低载波频率则与上述情况相反，过低的载波频率将引起低频运行不稳定，转矩降低甚至振荡现象。

变频器出厂时，已经对载波频率进行了合理的设置。一般情况下，用户无须对该参数进行更改。

H0.12	电机参数自学习	0: 无操作 1: 电机参数自学习	无	0	×
-------	---------	----------------------	---	---	---

0: 无操作，即禁止自学习。

1: 电机参数自学习

电机参数自学习前，必须将电机与负载脱开，让电机处于空载状态，并确认电机处于静止状态。

电机参数自学习前，必须正确输入电机铭牌参数（H2.01、H2.05），否则电机参数自学习的结果有可能不正确。

电机参数自学习前，应根据电机的惯性大小适当设置加、减速时间（H0.08、H0.09），否则电机参数自学习过程中有可能出现过流故障。

设定 H0.12 为 1 然后按 SET 键，开始电机参数自学习，此时 LED 显示“-TUN-”并闪烁，然后按 RUN 键开始进行参数自学习，此时显示“TUN-0”，电机运行后，显示“TUN-1”，“RUN”灯闪烁。当参数自学习结束后，显示“-END-”，最后显示回到停机状态界面。当“-TUN-”闪烁时可按 PRG 键退出参数自学习状态。

P30 五、功能参数说明

在参数自学习的过程中也可以按 STOP/RST 键中止参数自学习操作。注意，参数自学习的启动与停止只能由键盘控制；参数自学习完成以后，该功能码自动恢复到 0。

2: 参数静止自学习

电机参数静止自学习时，不必将电机与负载脱开，电机参自学习前，必须正确输入电机铭牌参数 (H2.00-H2.04)，自学习后将检测出电机的定子电阻、转子的电阻以及电机的漏感。而电机的互感和空载电流将无法测量，用户可根据输入相应的功能码。

H0.13	是否恢复缺省值	0: 无操作 1: 恢复缺省值	无	0	×
-------	---------	--------------------	---	---	---

1: 恢复缺省值：变频器将所有参数恢复缺省值。

H0.14	AVR 功能选择	0: 无效 1: 全程有效 2: 只在减速时无效	无	0	×
-------	----------	--------------------------------	---	---	---

AVR 功能即输出电压自动调整功能。当 AVR 功能无效时，输出电压会随输入电压（或直流母线电压）的变化而变化；当 AVR 功能有效时，输出电压不随输入电压（或直流母线电压）的变化而变化，输出电压在输出能力范围内将保持基本恒定。

注意：当电动机在减速停机时，将自动稳压 AVR 功能关闭会在更短的减速时间内停机而不会过压。

5.2.2 H1 组起停控制参数区

H1.00	起动运行方式选择	0: 直接起动 1: 先直流制动再起动 2: 转速追踪再起动	无	0	×
-------	----------	--------------------------------------	---	---	---

0: 直接起动：从起动频率开始起动。

1: 先直流制动再起动：先直流制动（注意设定参数 H1.03、H1.04），再从起动频率起动电机运行。适用小惯性负载在起动时可能产生反转的场合。

2: 转速追踪再起动：变频器首先计算电机的运转速度和方向，然后从当前速度开始运行到设定频率，以实现対旋转中电机实施平滑无冲击起动，该方式适用于大惯性负载的瞬时停电再起动。

H1.01	直接起动开始频率	0.00 ~ 10.00Hz	无	0.00Hz	√
H1.02	起动频率保持时间	0.0 ~ 50.0s	秒	0.0	√

设定合适的起动频率，可以增加起动时的转矩。在起动频率保持时间内（H1.02），变频器输出频率为起动频率，然后再从起动频率运行到目标频率，若目标频率（频率指令）小于起动频率，变频器将不运行，处于待机状态。起动频率值不受下限频率限制。

正反转切换过程中，起动频率不起作用。

H1.03	起动前制动电流	0.0 ~ 150.0	%	0.0	√
H1.04	起动前制动时间	0.0 ~ 50.0s	无	0.0s	√

变频器启动时先按设定的启动前直流制动电流进行直流制动，经过设定的启动前直流制动时间后再开始加速运行。若设定直流制动时间为 0，则直流制动无效。直流制动电流越大，制动力越大。启动前直流制动电流是指相对变频器额定电流的百分比。

H1.05	停机方式选择	0: 减速停车 1: 自由停车		0	√
-------	--------	--------------------	--	---	---

0: 减速停车

停机命令有效后，变频器按照减速方式及定义的加减速时间降低输出频率，频率降为 0 后停机。

1: 自由停车

停机命令有效后，变频器立即终止输出。负载按照机械惯性自由停车。

H1.06	停机制动开始频率	0.00 ~ H0.04	赫兹	0.00Hz	√
H1.07	停机制动等待时间	0.0 ~ 50.0s	秒	0.0s	√
H1.08	停机直流制动电流	0.0 ~ 150.0	%	0.0	√
H1.09	停机直流制动时间	0.0 ~ 50.0s	秒	0.0s	√

停机制动开始频率：减速停机过程中，当到达该频率时，开始停机直流制动。

停机制动等待时间：在停机直流制动开始之前，变频器封锁输出，经过该延时后再开始直流制动。用于防止在速度较高时开始直流制动引起的过流故障。

停机直流制动电流：指所加的直流制动量。电流越大，直流制动效果越强。

停机直流制动时间：直流制动量所持续的时间。时间为 0，直流制动无效，变频器按所设定的减速时间停车。



图 5-3 直流制动示意图

H1.10	正反转死区时间	0.0 ~ 3600.0s	秒	0.0s	√
-------	---------	---------------	---	------	---

设定变频器正反转过渡过程中，在输出零频处的过渡时间。

如下图所示：

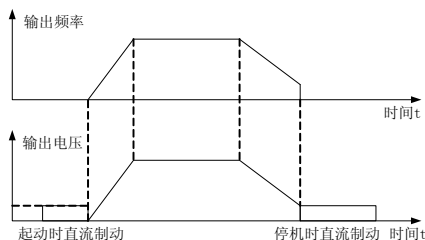

图 5-4 正反转死区时间示意图

H1.11	上电端子运行保护选择	0: 上电时端子运行命令无效 1: 上电时端子运行命令有效	无	0	√
-------	------------	--	---	---	---

在运行指令通道为端子控制时，变频器上电过程中，系统会自动检测运行端子的状态。
0: 上电时端子运行命令无效。即使在上电的过程中，检测到运行命令端子有效，变频器也不会运行，系统处于运行保护状态，直到撤消该运行命令端子，然后再使能该端子，变频器才会运行。

1: 上电时端子运行命令有效。即变频器在上电的过程中，如果检测到运行命令端子有效，等待初始化完成以后，系统会自动启动变频器运行。

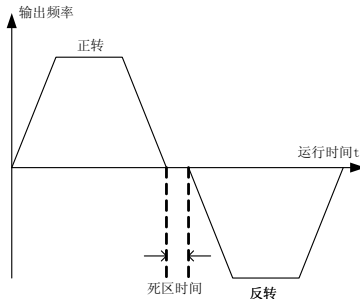
注意，用户一定要慎重选择该功能，可能会造成严重的后果。

H1.12	保留				
-------	----	--	--	--	--

5.2.3 H2 电机参数区

H2.00	变频器类型	0: G 型机		0	×
-------	-------	----------------	--	---	---

0: G 型机适用于指定额定参数的恒转矩负载

INFB7000 系列变频器适用于恒转矩负载；

变频器出厂参数设置为 G 型，

- ① 将该功能码设置为 0；
- ② 重新设置 H2 组电机参数。
- ① 将该功能码设置为 1；
- ② 重新设置 H2 组电机参数。

H2.01	电机额定功率	0.4 ~ 900.0kW	千瓦	机型设定	×
H2.02	电机额定频率	0.01Hz ~ H0.04	赫兹	50.00Hz	×
H2.03	电机额定转速	0 ~ 36000rpm	转 / 分钟	1400	×
H2.04	电机额定电压	0 ~ 460V	伏特	380	×
H2.05	电机额定电流	0.1 ~ 2000.0A	安培	机型设定	×

注意：请按照电机的铭牌参数进行设置。矢量控制的优良控制性能，需要准确的电机参数。

变频器提供参数自学习功能。准确的参数自学习来源于电机铭牌参数的正确设置。为了保证控制性能，请按变频器标准适配电机进行电机配置，若电机功率与标准适配电机差距过大，变频器的控制性能将明显下降。

注意：重新设置电机额定功率（H2.01），可以初始化 H2.02 至 H2.10 电机参数。

H2.06	电机定子电阻	0.001 ~ 65.535 Ω	欧姆	机型设定	✓
H2.07	电机转子电阻	0.001 ~ 65.535 Ω	欧姆	机型设定	✓
H2.08	电机定、转子电感	0.1 ~ 6553.5mH	毫亨	机型设定	✓
H2.09	电机定、转子互感	0.1 ~ 6553.5mH	毫亨	机型设定	✓
H2.10	电机空载电流	0.01 ~ 655.35A	安培	机型设定	✓

电机参数自学习正常结束后，H2.06 至 H2.10 的设定值自动更新。这些参数是高性能矢量控制的基准参数，对控制的性能有着直接的影响。

注意：用户不要随意更改该组参数。

5.2.4 H3 组矢量控制组

H3.00	速度环比例增益 1	0 ~ 100	无	20	✓
H3.01	速度环积分时间 1	0.01 ~ 10.00s	秒	0.50s	✓
H3.02	切换低点频率	0.00Hz ~ H3.05	赫兹	5.00Hz	✓
H3.03	速度环比例增益 2	0 ~ 100	无	25	✓
H3.04	速度环积分时间 2	0.01 ~ 10.00s	秒	1.00	✓
H3.05	切换高点频率	H3.02 ~ H0.04	赫兹	10.00Hz	✓

以上参数只对矢量控制有效，对 V/F 控制无效。在切换频率 1（H3.02）以下，速度环 PI 参数为：H3.00 和 H3.01。在切换频率 2（H3.05）以上，速度环 PI 参数为：H3.03 和 H3.04。在切换点之间，PI 参数由两组参数线性变化获得，如下图所示：



图 5-5 示意图

通过设定速度调节器的比例系数和积分时间，可以调节矢量控制的速度动态响应特性。增加比例增益，减小积分时间，均可加快速度环的动态响应，但比例增益过大或积分时间过小均容易导致系统振荡，超调过大。比例增益过小也容易导致系统稳态振荡，且有可能存在速度静差。

速度环 PI 参数与电机系统的惯性关系密切，用户针对不同的负载特性需要在缺省 PI 参数的基础上进行调整，以满足各种场合的需求。

H3.06	VC 转差补偿系数	50% ~ 200%	%	100%	√
-------	-----------	------------	---	------	---

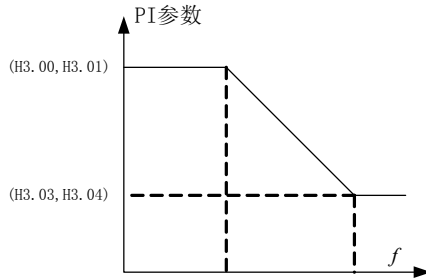
转差补偿系数用于调整矢量控制的转差频率，改善系统的速度控制精度，适当调整该参数，可以有效抑制速度静差。

H3.07	转矩上限设定	0.0 ~ 200.0% (变频器额定电流)	%	150.0%	√
-------	--------	---------------------------	---	--------	---

设定 100.0% 对变频器的额定输出电流。

5.2.5 H4 组 V/F 控制区

H4.00	V/F 曲线设定	0: 直线 V/F 曲线 1: 2.0 次幂降转矩 V/F 曲线	无	0	×
-------	----------	-------------------------------------	---	---	---

本组功能码对 V/F 控制有效 (H0.00 = 1)，对矢量控制无效。

风机水泵类负载，可以选择平方 V/F 控制。

0: 直线 V/F 曲线。适合于普通恒转矩负载。

1: 2.0 次幂 V/F 曲线。适合于风机、水泵等离心负载。



图 5-6 V/F 曲线示意图

H4.01	转矩提升	0.0%: (自动) 0.1%~30.0%	%	0.0%	√
H4.02	转矩提升截止	0.0%~50.0% (相对电机 额定频率)	%	20.0%	×

转矩提升主要应用于截止频率（H4.12）以下，提升后的 V/F 曲线如下图所示，转矩提升可以改善 V/F 的低频转矩特性。

应根据负载大小适当选择转矩量，负载大可以增大提升，但转矩提升不应设置过大，过大的转矩提升，电机过励磁运行，容易过热，变频器输出电流大，效率降低。当转矩提升设置为 0.0% 时，变频器为自动转矩提升。

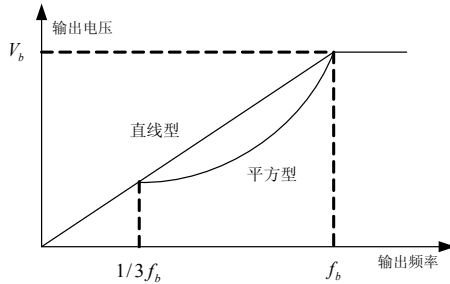
转矩提升截止频率：在此频率之下，转矩提升有效，超过此设定频率，转矩提升失效。



图 5-7 手动转矩提升示意图

H4.03	V/F 转差补偿限定	0.0~200.0%	%	100.0%	√
-------	------------	------------	---	--------	---

设定此参数可以补偿 V/F 控制时因为带负载产生的电机转速变化，以提高电机机械特性的硬度，此值应对应电机的额定转差频率。

H4.04	节能运行选择	0: 不动作 1: 自动节能运行	无	0	√
H4.05	保留				

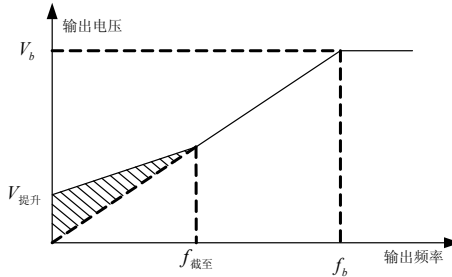
5.2.6 H5 输入端子区

H5.00	X1 端子功能选择	0: 无功能 1: 正转运行 2: 反转运行 3: 三线式运行控制		1	×
H5.01	X2 端子功能选择	4: 正转点动 5: 反转点动 6: 自由停车 7: 故障复位	无	4	×
H5.02	X3 端子功能选择	8: 外部故障输入 9: 频率设定递增 (UP) 10: 频率设定递减 (DOWN) 11: 频率增减设定清除	无	7	×
H5.03	X4 端子功能选择	12: 多段速端子 1 13: 多段速端子 2 14: 多段速端子 3	无	0	×
H5.04	X5 端子功能选择	15: 保留 16: PID 控制暂停 17: 摆频暂停 (停在当前频率) 18: 摆频复位 (回到中心频率) 19: 加减速禁止	无	0	×
H5.05	X6 端子功能选择	20: 转矩控制禁止 21: 频率增减设定暂时清除 22 ~ 25: 保留	无	0	×

0: 无功能 即使有信号输入变频器也不动作。可将未使用的端子设定无功能防止误动作。

1: 正转运行 **2:** 反转运行 通过外部端子来控制变频器正转与反转。

3: 三线式运行控制 通过此端子来确定变频器运行方式是三线控制模式。详细说明请参考 H5.07 三线制控制模式功能码介绍。

4: 正转点动 **5:** 反转点动

点动运行时频率、点动加减速时间参见 H8.02、H8.03、H8.04 功能码的详细说明。

6: 自由停车 变频器封锁输出，电机停车过程不受变频器控制。对于大惯量的负载而且对停车时间没有要求时，经常所采取的方法。此方式和 H1.05 所述的自由停车的含义是相同的。

7: 故障复位 外部故障复位功能。与键盘上的 STOP/RST 键功能相同。用此功能可实现远距离故障复位。

8: 外部故障输入 当外部故障信号送给变频器后，变频器报出故障并停机。

9: 频率设定递增 (UP) **10:** 频率设定递减 (DOWN) **11:** 频率增减设定清除

由外部端子给定频率时修改频率递增指令、递减指令。在频率源设定为数字设定时可上下调节设定频率。



图 5-8 端子调速示意图

用端子可清除 UP/DOWN 设定的频率值，使给定频率恢复到由频率指令通道给定的频率。

12: 多段速端子 1 **13:** 多段速端子 2 **14:** 多段速端子 3

可通过此三个端子的数字状态组合共可实现 8 段速的设定。注意：多段速 1 为低位，多段速 3 为高位。

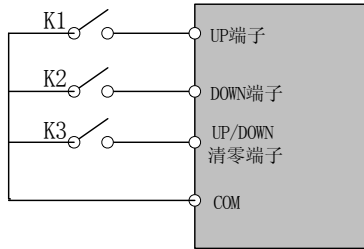
15: 保留

16: PID 控制暂停 PID 暂时失效，变频器维持当前频率输出。

17: 摆频暂停（停在当前频率）变频器暂停在当前输出频率，功能撤销后，继续以当前频率开始摆频运行。

18: 摆频复位（回到中心频率）变频器回到中心频率输出。

19: 加减速禁止 保证变频器不受外来信号影响（停机命令除外），维持当前输出频率。

20: 转矩控制禁止 禁止变频器进行转矩控制方式，变频器将切换到速度控制方式。

21: 频率增减设定暂时清除 当端子闭合时可清除 UP/DOWN 设定的频率值，使给定频率恢复到由

频率指令通道给定的频率，当端子断开时重新回到频率增减设定后的频率值。

22 ~ 25: 保留

H5.06	开关量滤波次数	1 ~ 10	无	5	√
-------	---------	--------	---	---	---

设置 X1 ~ X4 端子采样的滤波时间。在干扰大的情况下，应增大该参数，以防止误操作。

H5.07	端子控制运行模式	0: 两线式控制 1 1: 两线式控制 2 2: 三线式控制 1 3: 三线式控制 2	无	0	×
-------	----------	--	---	---	---

该参数定义了通过外部端子控制变频器运行的四种不同方式。

0: 两线式控制 1。此模式为最常使用的两线模式。由 FWD、REV 端子命令来决定电机的正、反转。



图 5-9 两线式运转模式 1 示意图

1: 两线式控制 2。用此模式时 FWD 为使能端子。方向由 REV 的状态来确定。

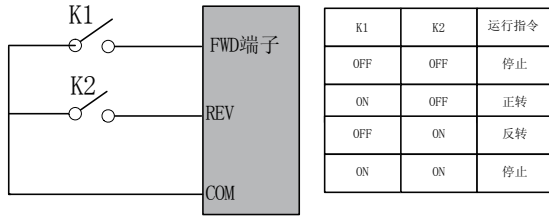

图 5-10 两线式运转模式 2 示意图

2: 三线式控制 1。此模式 SIn 为使能端子，运行命令由 FWD 产生，方向命令由 REV 产生。SIn 为常闭输入。

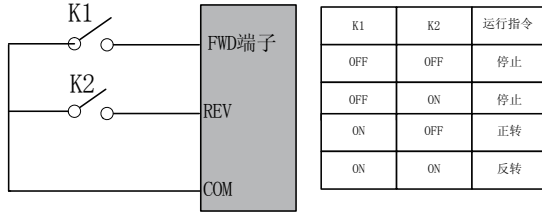

图 5-11 三线式运转模式 1 示意图

其中 :K: 正反转开关 SB1: 运行按钮 SB2: 停机按钮

SIn 为将对应的端子功能定义为 3 号功能“三线制运行功能”即可。

3: 三线式控制 2。此模式 SIn 为使能端子，运行命令由 SB1 或 SB2 产生，并且同时控制运行方向。停机命令由常闭输入的 SB2 产生。

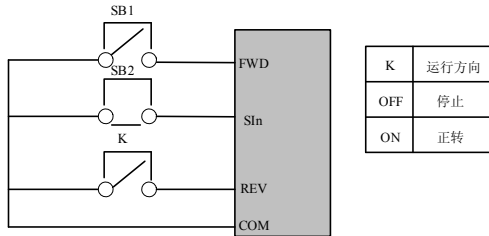

图 5-12 三线式运转模式 2 示意图

其中：SB1: 正转运行按钮 SB2: 停机按钮 SB3: 反转运行按钮

SIn 为将对应的端子功能定义为 3 号功能“三线式运转控制”。

提示：对于两线式运转模式，当 FWD/REV 端子有效时，由其他来源产生停机命令而使变频器停机时，即使控制端子 FWD/REV 仍然保持有效，在停机命令消失后变频器也不会运行。如果要使变频器运行，需再次触发 FWD/REV。

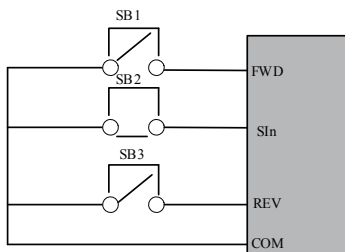
H5.08	端子上升下降频率增量变化率	0.01 ~ 50.00Hz/s	赫兹 / 秒	0.50Hz/s	√
-------	---------------	------------------	--------	----------	---

端子上升下降频率来调整设定频率时的变化率。

H5.09	VIN 下限值	0.00V ~ 10.00V	伏特	0.00V	√
H5.10	VIN 下限对应设定	-100.0% ~ 100.0%	%	0.0%	√
H5.11	VIN 上限值	0.00V ~ 10.00V	伏特	10.00V	√
H5.12	VIN 上限对应设定	-100.0% ~ 100.0%	%	100.0%	√
H5.13	VIN 输入滤波时间	0.00s ~ 10.00s	秒	0.10s	√

上述功能码定义了模拟输入电压与模拟输入对应的设定值之间的关系，当模拟输入电压超过设定的最大输入或最小输入的范围，以外部分将以最大输入或最小输入计算。模拟输入为电流输入时，0mA ~ 20mA 电流对应 0V ~ 10V 电压。

在不同的应用场合，模拟设定的 100.0% 所对应的标称值有所不同，具体请参考各个应用部分的说明。

下图例说明了几种设定的情况：注意：VIN 的下限值一定要小于或等于 VIN 的上限值。



图 5-13 模拟给定与设定量的对应关系

P40 五、功能参数说明

VIN 输入滤波时间: 确定模拟量输入的灵敏度。若防止模拟量受到干扰而引起误动作, 可将此参数增大, 则抗干扰能力增强, 但引起模拟量的输入的灵敏度降低。

H5.14	SIN 下限值	0.00V ~ 10.00V	伏特	0.00V	√
H5.15	SIN 下限对应设定	-100.0% ~ 100.0%	%	0.0%	√
H5.16	SIN 上限值	0.00V ~ 10.00V	伏特	10.00V	√
H5.17	SIN 上限对应设定	-100.0% ~ 100.0% 100.0%	%	100.0%	√
H5.18	SIN 输入滤波时间	0.00s ~ 10.00s	秒	0.10s	√

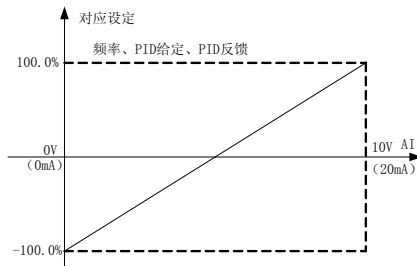
SIN 的功能与 VIN 的设定方法类似。模拟量 SIN 可支持 0 ~ 10V 或 0 ~ 20mA 输入, 当 SIN 选择 0 ~ 20mA 输入时 20mA 对应的电压为 10V。

5.2.7 H6 输出端子区

H6.00	Y1	0: 无输出 1: 电机正转运行中 2: 电机反转运行中 3: 故障输出 4: 频率水平检测 FDT 输出 5: 频率到达 6: 零速运行中 7: 上限频率到达 8: 下限频率到达 9 ~ 10: 保留	无	1	√
H6.01	Y2		无	0	√
H6.02	Y3		无	0	√
H6.03	继电器输出选择		无	3	√

0: 无输出 输出端子无任何功能

1: 电机正转运行中 表示变频器正转运行, 有输出频率。此时输出 ON 信号。

2: 电机反转运行中 表示变频器反转运行, 有输出频率。此时输出 ON 信号。

3: 故障输出 当变频器发生故障时, 输出 ON 信号。

4: 频率水平检测 FDT 输出 请参考功能码 H8.11、H8.12 的详细说明。

5: 频率到达 请参阅功能码 H8.13 的详细说明。

6: 零速运行中 变频器输出频率小于起动频率时, 输出 ON 信号。

7: 上限频率到达 运行频率到达上限频率时, 输出 ON 信号

8: 下限频率到达 运行频率到达下限频率时, 输出 ON 信号

H6.04	FM(AM) 输出选择	0: 运行频率 1: 设定频率 2: 运行转速 3: 输出电流 4: 输出电压 5: 输出功率 6: 输出转矩 7: 模拟 VIN 输入值 8: 模拟 SIN 输入值 9 ~ 10: 保留	无	0	√
-------	-------------	---	---	---	---

*FM(AM) 两者共用一路输出

模拟输出的标准输出为 0 ~ 20mA (或 0 ~ 10V), 可通过跳线选择电流或电压输出。

其表示的相对量度的范围如下:

0: 运行频率 0 ~ 最大输出频率

1: 设定频率 0 ~ 最大输出频率

2: 运行转速 0 ~ 2 倍电机额定转速

3: 输出电流 0 ~ 2 倍变频器额定电流

4: 输出电压 0 ~ 1.5 倍变频器额定电压

5: 输出功率 0 ~ 2 倍额定功率

6: 输出转矩 0 ~ 2 倍电机额定电流

7: 模拟 VIN 输入值 0 ~ 10V

8: 模拟 SIN 输入值 0 ~ 10V/0 ~ 20mA

H6.05	FM(AM) 输出下限	0.0% ~ 100.0%	0.0%	0.0%	√
H6.06	下限对应 FM(AM) 输出	0.00V ~ 10.00V	0.00V	0.00V	√
H6.07	FM(AM) 输出上限	0.0% ~ 100.0%	100.0%	100.0%	√
H6.08	上限对应 FM(AM) 输出	0.00V ~ 10.00V	10.00V	10.00V	√

上述功能码定义了输出值与模拟输出对应的输出值之间的关系，当输出值超过设定的最大输出或最小输出的范围，以外部分将以最大输出或最小输出计算。

模拟输出为电流输出时，1mA 电流相当于 0.5V 电压。

在不同的应用场合，输出值的 100% 所对应的模拟输出量有所不同，具体请参考各个应用部分的说明。

下图说明了几种设定的情况



图 5-14 给定量与模拟量输出的对应关系

5.2.8 H7 组人机界面区

H7.00	用户密码	0 ~ 65535	无	0	√
-------	------	-----------	---	---	---

设定为任意一个非零的数字，密码保护功能生效。

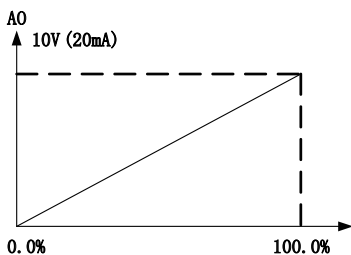
00000：清除以前设置用户密码值，并使密码保护功能无效，恢复出厂值也能清除密码。

当用户密码设置并生效后，如果用户密码不正确，用户将不能进入参数菜单，只有输入正确的用户密码，用户才能查看参数，并修改参数。请牢记所设置的用户密码。退出功能码编辑状态，密码保护将在 1 分钟后生效，当密码生效后若按 PRG 键进入功能码编辑状态时，将显示“00000”，操作者必须正确输入用户密码，否则无法进入。

P42 五、功能参数说明

H7.03	QUICK/JOG 键功能选择	0: 寸动运行 1: 正转反转切换 2: 清除 UP/DOWN 设定	无	0	×
-------	-----------------	---	---	---	---

QUICK/JOG 键，即为多功能键。可通过参数设置定义键盘 QUICK/JOG 键的功能。

0: 寸动运行。键盘 QUICK/JOG 键实现寸动运行。

1: 正转反转切换。键盘 QUICK/JOG 键实现切换频率指令的方向。只在键盘命令通道时有效。

2: 清除 UP/DOWN 设定。键盘 QUICK/JOG 键对 UP/DOWN 的设定值进行清除。

H7.04	STOP/RST 键停机功能选择	0: 只对操作面板控制有效 1: 对操作面板和端子控制同时有效 2: 对面板和通讯控制同时有效 3: 所有控制模式都有效	无	0	√
-------	------------------	---	---	---	---

该功能码定义了 STOP/RST 停机功能有效的选择。对于故障复位，STOP/RST 键任何状况下都有效。

H7.05	键盘显示选择	0: 外引键盘优先显示 1: 本机、外引键盘同时显示，只外引按键有效 2: 本机、外引键盘同时显示，只本机按键有效	无	0S	√
-------	--------	--	---	----	---

该功能设定本机键盘和外引键盘的显示按键作用逻辑关系。

注意：3 号功能要谨慎使用。误操作可能造成严重后果。

H7.06	运行状态显示的参数选择	0 ~ 0x7FFF FE: 运行频率 Fd: 设定频率 FC: 母线电压 Fb: 输出电压 FA: 输出电流 F9: 运行转速 F8: 输出功率 F7: 输出转矩 F6: PID 给定值 F5: PID 反馈值 F4: 输入端子状态 F3: 输出端子状态 F2: 模拟量 VIN 值 F1: 模拟量 SIN 值 F0: 多段速当前段数	无	0xFF	√
-------	-------------	---	---	------	---

变频器在运行状态下，参数显示受该功能码作用，即为一个 16 位的二进制数，如果某一位为 1，则该位对应的参数就可在运行时，通过移位键查看。如果该位为 0，则该位对应的参数将不会显示。设置功能码 H7.06 时，要将二进制数转换成十六进制数，输入该功能码。

低 8 位 BIT7 ~ BIT0 和高 8 位 BIT15 ~ BIT8 表示的显示内容如上表。

H7.07	停机状态显示的参数选择	1 ~ 0x1FF FE: 设定频率 Fd: 母线电压 FC: 输入端子状态 Fb: 输出端子状态 FA: PID 给定值 F9: PID 反馈值 F8: 模拟量 VS1 值 F7: 模拟量 SIN 值 F6: 多段速当前段数 F5 ~ F0: 保留	无	0xFF	√
-------	-------------	---	---	------	---

该功能的设置与 P6-06 的设置相同。只是变频器处于停机状态时，参数的显示受该功能码作用。低 8 位 BIT7 ~ BIT0 和高 8 位 BIT15 ~ BIT8 表示的显示内容如上表。

H7.08	整流模块温度	0 ~ 100.0°C	度		
H7.09	逆变模块温度	0 ~ 100.0°C	度		
H7.10	软件版本		无	3.00	
H7.11	本机累积运行时间	0 ~ 65535h	小时	0	

这些功能码只能查看，不能修改。

整流模块温度：表示整流模块的温度，不同机型的整流模块过温保护值可能有所不同。
逆变模块温度：显示逆变模块 IGBT 的温度，不同机型的逆变模块 IGBT 过温保护值可能有所不同。

软件版本：软件版本号。

本机累积运行时间：显示到目前为至变频器的累计运行时间。

H7.12	前两次故障类型	0: 无故障 1: 逆变单元 U 相保护 (E001) 2: 逆变单元 V 相保护 (E002) 3: 逆变单元 W 相保护 (E003) 4: 加速过电流 (E004) 5: 减速过电流 (E005) 6: 恒速过电流 (E006) 7: 加速过电压 (E007) 8: 减速过电压 (E008)	无		
H7.13	前一次故障类型	9: 恒速过电压 (E009) 10: 母线欠压故障 (E010) 11: 电机过载 (E011) 12: 变频器过载 (E012) 13: 输入侧缺相 (E013) 14: 输出侧缺相 (E014) 15: 整流模块过热 (E015) 16: 逆变模块过热故障 (E016) 17: 外部故障 (E017)	无		

H7.14	当前故障类型	18: 通讯故障 (E018) 19: 电流检测故障 (E019) 20: 电机自学习故障 (E020) 21: EEPROM 操作故障 (E021) 22: PID 反馈断线故障 (E022) 23: 制动单元故障 (E023) 24: 保留	无		
-------	--------	---	---	--	--

记录变频器最近的十次故障类型：0 为无故障，1 ~ 24 为不同的 24 种故障（详细功能见此表）。

H7.15	当前故障运行		赫兹		
H7.16	当前故障输出电流		安培	0.0A	
H7.17	当前故障母线电压		伏特	0.0V	
H7.18	当前故障输入端子状态		无	0	
H7.19	当前故障输出端子状态		无	0	

当前故障运行频率：当前故障时的输出频率。

当前故障输出电流：当前故障时的输出电流。

当前故障母线电压：当前故障时的母线电压。

5.2.9 H8 组增强参数区

H8.00	加速时间 2	0.1 ~ 3600.0s	秒	20.00s	√
H8.01	减速时间 2	0.1 ~ 3600.0s	秒	20.00s	√
H8.02	点动运行频率	0.00 ~ H0.04	赫兹	5.00Hz	√
H8.03	点动运行加速时间	0.1 ~ 3600.0s	秒	20.00s	√
H8.04	点动运行减速时间	0.1 ~ 3600.0s	秒	20.00s	√

定义点动运行时变频器的给定频率及加减速时间。点动运行过程按照直接起动方式和减速停机方式进行起停操作。

点动运行加速时间指变频器从 0Hz 加速到最大输出频率（H0.04）所需时间。

点动运行减速时间指变频器从最大输出频率（H0.04）减速到 0Hz 所需时间。

H8.05	跳跃频率	0.00 ~ H0.04	赫兹	0.00Hz	√
H8.06	跳跃频率幅度	0.00 ~ H0.04	赫兹	0.00Hz	√

当设定频率在跳跃频率范围内时，实际运行频率将会运行在离设定频率最近的跳跃频率边界。

通过设置跳跃频率，使变频器避开负载的机械共振点。本变频器可设置一个跳跃频率点。若将跳跃频率均设为 0 则此功能不起作用。



图 5-15 跳跃频率示意图

H8.07	摆频幅度	0.0 ~ 100.0% (相对设定频率)	%	0.0%	✓
H8.08	突跳频率幅度	0.0 ~ 50.0% (相对摆频幅度)	%	0.0%	✓
H8.09	摆频上升时间	0.1 ~ 3600.0s	秒	5.0s	✓
H8.10	摆频下降时间	0.1 ~ 3600.0s	秒	5.0s	✓

摆频功能适用于纺织、化纤等行业及需要横动、卷绕功能的场合。

摆频功能是指变频器输出频率以设定频率为中心进行上下摆动，运行频率在时间轴的轨迹如下图所示，其中摆动幅度由 H8.07 设定，当 H8.07 设为 0 时，即摆幅为 0，摆频不起作用。

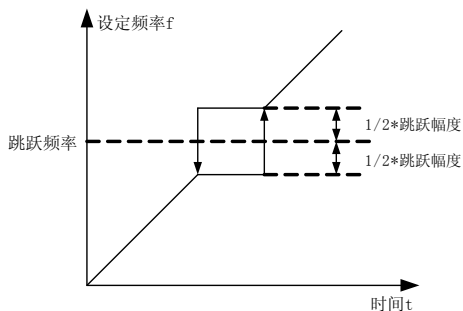

图 5-16 摆频运行示意图

摆频幅度：摆频运行频率受上、下限频率约束。

摆幅相对于中心频率：摆幅 $AW = \text{中心频率} \times \text{摆频幅度 H8.07}$ 。

突调频率 = 摆幅 $AW \times \text{突跳频率幅度 H8.08}$ 。即摆频运行时，突调频率相对摆幅的值。

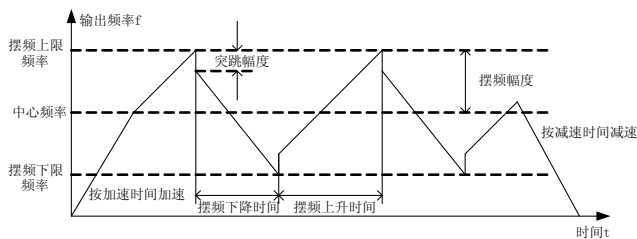
摆频上升时间：从摆频的最低点运行到最高点所用的时间。

摆频下降时间：从摆频的最高点运行到最低点所用的时间。

H8.11	故障自动复位次数	0 ~ 3	无	0	
H8.12	故障自动复位间隔时间设置	0.1 ~ 100.0s	秒	1.0s	

故障自动复位次数：当变频器选择故障自动复位时，用来设定可自动复位的次数。

P46 五、功能参数说明

超过此值变频器故障待机，等待修复。

故障自动复位间隔时间设置：选择从故障发生到自动复位动作之间的时间间隔。

H8.13	FDT 电平检测值	0.00 ~ H0.04	赫兹	50.00Hz	√
H8.14	FDT 滞后检测值	0.0 ~ 100.0% (FDT 电平)	%	5.0%	√

设定输出频率的检测值和输出动作解除的滞后值。如下图所示：



图 5-17 FDT 电平示意图

H8.15	频率到达检出幅度	0.0 ~ 100.0% (最大频率)	%	0.0%	√
-------	----------	------------------------	---	------	---

变频器的输出频率达到设定频率值时，此功能可调整其检测幅值。如下图所示：

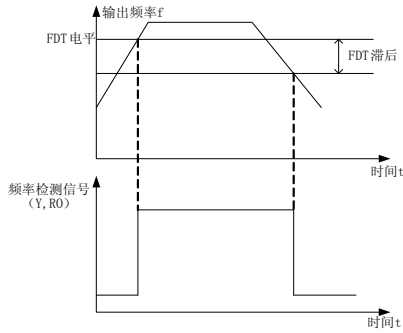

图 5-18 频率到达检出幅值示意图

H8.16	制动阈值电压	115.0 ~ 140.0% (标准母线电压)	%	125.0%	√
-------	--------	----------------------------	---	--------	---

该功能码是设置能耗制动的起始母线电压，适当调整该值可有效对负载进行制动。

H8.17	转速显示系数	0.1 ~ 999.9% 机械转速 = 120 * 运行频率 * H8.17 / 电机极对数	%	100.0%	√
-------	--------	---	---	--------	---

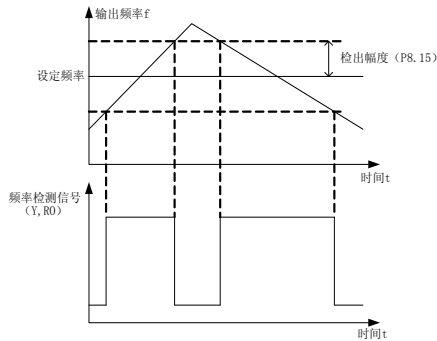
机械转速 = 120 × 运行频率 × H8.17 / 电机极对数，本功能码用于校正转速刻度显示误差，对实际转速没有影响。

5.2.10 H9组 PID 参数区

PID 控制是用于过程控制的一种常用方法，通过对被控量的反馈信号与目标量信号的差量进行比例、积分、微分运算，来调整变频器的输出频率，构成负反馈系统，使被控量稳定在目标量上。适用于流量控制、压力控制及温度控制等过程控制。控制基本原理框图如下：



图 5-23 过程 PID 原理框图

H9.00	PID 给定源选择	0: 键盘给定 1: 模拟通道 VIN 给定 2: 模拟通道 SIN 给定 3: 远程通讯给定 4: 多段给定	无	0	√
-------	-----------	---	---	---	---

当频率源选择 PID 时，即 H0.03 选择为 5，该组功能起作用。此参数决定过程 PID 的目标量给定通道。

过程 PID 的设定目标量为相对值，设定的 100% 对应于被控系统的反馈信号的 100%；系统始终按相对值（0 ~ 100.0%）进行运算的。

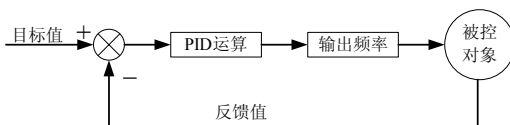
H9.01	键盘预置 PID 给定	0.0% ~ 100.0%	%	0.0%	×
-------	-------------	---------------	---	------	---

选择 H9.00=0 时，即目标源为键盘给定。需设定此参数。

H9.02	PID 反馈源选择	0: 模拟通道 VIN 反馈 1: 模拟通道 SIN 反馈 2: VIN+SIN 反馈 3: 远程通讯反馈	无	0	√
-------	-----------	--	---	---	---

通过此参数来选择 PID 反馈通道。

注意：给定通道和反馈通道不能重合，否则，PID 不能有效控制。

H9.03	PID 输出特性选择	0: PID 输出为正特性 1: PID 输出为负特性	无	0	√
-------	------------	--------------------------------	---	---	---

PID 输出为正特性：当反馈信号大于 PID 的给定，要求变频器输出频率下降，才能使 PID 达到平衡。如收卷的张力 PID 控制。

PID 输出为负特性：当反馈信号大于 PID 的给定，要求变频器输出频率上升，才能使 PID 达到平衡。如放卷的张力 PID 控制。

H9.04	比例增益 (Kp)	0.00 ~ 100.00	无	1.00	✓
H9.05	积分时间 (Ti)	0.01 ~ 10.00s	秒	0.10s	✓
H9.06	微分时间 (Td)	0.00 ~ 10.00s	秒	0.00s	✓

比例增益 (Kp): 决定整个 PID 调节器的调节强度, P 越大, 调节强度越大。该参数为 100 表示当 PID 反馈量和给定量的偏差为 100% 时, PID 调节器对输出频率指令的调节幅度为最大频率 (忽略积分作用和微分作用)。

积分时间 (Ti): 决定 PID 调节器对 PID 反馈量和给定量的偏差进行积分调节的快慢。积分时间是指当 PID 反馈量和给定量的偏差为 100% 时, 积分调节器 (忽略比例作用和微分作用) 经过该时间连续调整, 调整量达到最大频率 (H0.04)。积分时间越短调节强度越大。

微分时间 (Td): 决定 PID 调节器对 PID 反馈量和给定量的偏差的变化率进行调节的强度。微分时间是指若反馈量在该时间内变化 100%, 微分调节器的调整量为最大频率 (H0.04) (忽略比例作用和积分作用)。微分时间越长调节强度越大。

PID 是过程控制中最常用的控制方法, 其每一部分所起的作用各不相同, 下面对工作原理简要和调节方法简单介绍:

比例调节 (P): 当反馈与给定出现偏差时, 输出与偏差成比例的调节量, 若偏差恒定, 则调节量也恒定。比例调节可以快速响应反馈的变化, 但单纯用比例调节无法做到无差控制。比例增益越大, 系统的调节速度越快, 但若过大会出现振荡。调节方法为先将积分时间设很长, 微分时间设为零, 单用比例调节使系统运行起来, 改变给定量的大小, 观察反馈信号和给定量的稳定的偏差 (静差), 如果静差在给定量改变的方向上 (例如增加给定量, 系统稳定后反馈量总小于给定量), 则继续增加比例增益, 反之则减小比例增益, 重复上面的过程, 直到静差比较小 (很难做到一点静差没有) 就可以了。

积分时间 (I): 当反馈与给定出现偏差时, 输出调节量连续累加, 如果偏差持续存在, 则调节量持续增加, 直到没有偏差。积分调节器可以有效地消除静差。积分调节器过强则会出现反复的超调, 使系统一直不稳定, 直到产生振荡。由于积分作用过强引起的振荡的特点是, 反馈信号在给定量的上下摆动, 摆幅逐步增大, 直至振荡。积分时间参数的调节一般由大到小调, 逐步调节积分时间, 观察系统调节的效果, 直到系统稳定的速度达到要求。

微分时间 (D): 当反馈与给定的偏差变化时, 输出与偏差变化率成比例的调节量, 该调节量只与偏差变化的方向和大小有关, 而与偏差本身的方向和大小无关。微分调节的作用是在反馈信号发生变化时, 根据变化的趋势进行调节, 从而抑制反馈信号的变化。微分调节器请谨慎使用, 因为微分调节容易放大系统的干扰, 尤其是变化频率较高的干扰。

H9.07	采样周期 (T)	0.01 ~ 100.00s	秒	0.10s	✓
H9.08	PID 控制偏差极限	0.0 ~ 100.0%	%	0.0%	✓

采样周期 (T): 指对反馈量的采样周期, 在每个采样周期内调节器运算一次。采样周期越大响应越慢。

PID 控制偏差极限 :PID 系统输出值相对于闭环给定值允许的最大偏差量, 如图所示, 在偏差极限内, PID 调节器停止调节。合理设置该功能码可调节 PID 系统的精度和稳定性。



图 5-24 偏差极限与输出频率的对应关系

H9.09	反馈断线检测值	0.0 ~ 100.0%	%	0.0%	√
H9.10	反馈断线检测时间	0.0 ~ 3600.0s	秒	1.0s	√

反馈断线检测值: 该检测值相对的是满量程 (100%), 系统一直检测 PID 的反馈量, 当反馈值小于或者等于反馈断线检测值, 系统开始检测计时。当检测时间超出反馈断线检测时间, 系统将报出 PID 反馈断线故障 (PIDE)。

5.2.11 HA 组多段速参数区

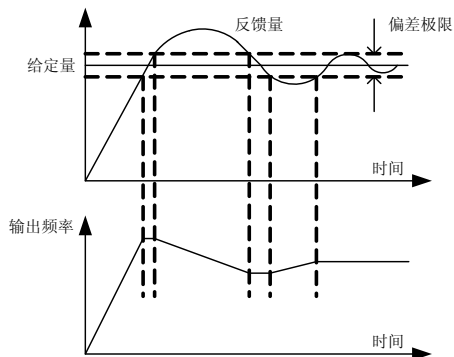
Ha.00	多段速 0	-100.0 ~ 100.0%	%	0.0%	√
Ha.01	多段速 1	-100.0 ~ 100.0%	%	0.0%	√
Ha.02	多段速 2	-100.0 ~ 100.0%	%	0.0%	√
Ha.03	多段速 3	-100.0 ~ 100.0%	%	0.0%	√
Ha.04	多段速 4	-100.0 ~ 100.0%	%	0.0%	√
Ha.05	多段速 5	-100.0 ~ 100.0%	%	0.0%	√
Ha.06	多段速 6	-100.0 ~ 100.0%	%	0.0%	√
Ha.07	多段速 7	-100.0 ~ 100.0%	%	0.0%	√

说明: 多段速的符号决定运行方向。若为负值, 则表示反方向运行。频率设定 100.0% 对应最大频率 (H0.04)。

X1=X2=X3=OFF 时, 频率输入方式由代码 H0.03 选择。X1、X2、X3 端子不全为 OFF 时, 多段速运行, 多段速度的优先级高于键盘、模拟、通讯频率输入, 通过 X1、X2、X3 组合编码, 最多可选择 8 段速度。



图 5-19 多段速度运行逻辑图

多段速度运行时的启动停车通道选择同样由功能码 H0.01 确定，多段速控制过程如图 5-19 所示。X1、X2、X3 端子与多段速度段的关系如下表所示。

多段速度段与 X1、X2、X3 端子的关系

X1	OFF	ON	OFF	ON	OFF	ON	OFF	ON
X2	OFF	OFF	ON	ON	OFF	OFF	ON	ON
X3	OFF	OFF	OFF	OFF	ON	ON	ON	ON
运行段	0	1	2	3	4	5	6	7

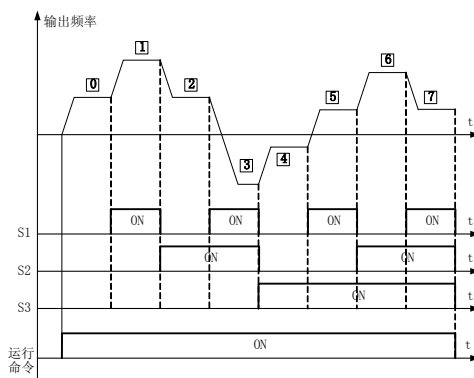
5.2.12 Hb 组保护和故障参数区

Hb.00	电机过载保护选择	0: 不保护 1: 普通电机 (带低速补偿) 2: 变频电机 (不带低速补偿)	无	1	×
-------	----------	---	---	---	---

0: 不保护。没有电机过载保护特性 (谨慎使用), 此时, 变频器对负载电机没有过载保护。

1: 普通电机 (带低速补偿)。由于普通电机在低速情况下的散热效果较差, 相应的电子热保护值也作适当调整, 这里所说的带低速补偿特性, 就是把运行频率低于 30HZ 的电机过载保护阀值下调。

2: 变频电机 (不带低速补偿)。由于变频专用电机的散热不受转速影响, 不需要进行低速运行时的保护值调整。

Hb.01	电机过载保护电流	20.0% ~ 120.0% (电机额定电流)	%	100.0%	√
-------	----------	----------------------------	---	--------	---



图 5-20 电机过载保护系数设定

此值可由下面的公式确定：

电机过载保护电流 = (允许最大的负载电流 / 变频器额定电流) * 100%。

一般定义允许最大负载电流为负载电机的额定电流。

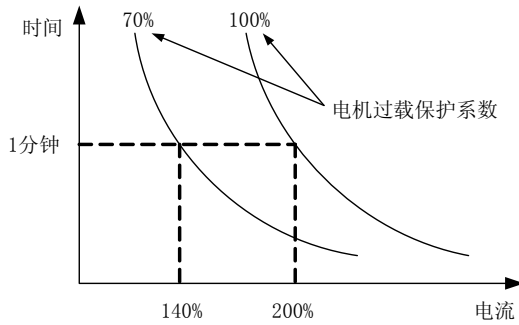
当负载电机的额定电流值与变频器的额定电流不匹配时，通过设定 Hb.00 ~ Hb.01 的值可以实现对电机的过载保护。

Hb.02	瞬间掉电降频点	70.0 ~ 110.0% (标准母线电压)	%	80.0%	√
Hb.03	瞬间掉电频率下降率	0.00Hz ~ H0.04	赫兹	0.00Hz	√

当瞬间掉电频率下降率设置为 0 时，瞬间掉电再启动功能无效。

瞬间掉电降频点：指的是在电网掉电以后，母线电压降到瞬间掉电降频点时，变频器开始按照瞬间掉电频率下降率（Hb.03）降低运行频率，使电机处于发电状态，让回馈的电能去维持母线电压，保证变频器的正常运行，直到变频器再一次上电。

注意：适当调整这两个参数，可以很好地实现电网切换，而不会引起变频器保护而造成的生产停机。

Hb.04	过压失速保护	0: 禁止 1: 允许	无	0	√
Hb.05	过压失速保护电压	110 ~ 150% (380V 系列)	%	120%	√

变频器减速运行过程中，由于负载惯性的影响，可能会出现电机转速的实际下降率低于输出频率的下降率，此时，电极会回馈电能给变频器，造成变频器的母线电压上升，如果不采取措施，则会造成母线过压故障而引起变频器跳闸。

过压失速保护功能在变频器运行过程中通过检测母线电压，并于 Hb.05（相对于标准母线电压）定义的失速过压点进行比较，如果超过失速过压点，变频器输出频率停止下降，当再次检测母线电压低于过压失速点后，再继续减速运行。

如图所示：



图 5-21 过压失速功能

Hb.06	自动限流水平	100 ~ 200%	%	200%	√
Hb.07	限流时频率下降率	0.00 ~ 100.00Hz/s	赫兹 / 秒	00.00Hz/s	√

变频器在运行过程中,由于负载过大,电机转速的实际上升率低于输出频率的上升率,如果不采取措施,则会造成加速过流故障而引起变频器跳闸。

过流失速保护功能在变频器运行过程中通过检测输出电流,并与 Hb.06 定义的限流水平点进行比较,如果超过限流水平点,变频器输出频率按照过流频率下降率 (Hb.07) 进行下降,当再次检测输出电流低于限流水平点后,再恢复正常运行。如图:

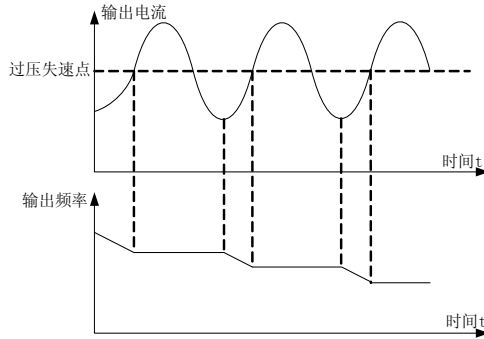

图 5-22 限流保护功能示意图

5.2.13 Hc 组 485 参数区

Hc.00	本机通讯地址	1 ~ 247, 0 为广播地址	无	1	√
-------	--------	------------------	---	---	---

当主机在编写帧中, 从机通讯地址设定为 0 时, 即为广播通讯地址, MODBUS 总线上的所有从机都会接受该帧, 但从机不做应答。注意, 从机地址不可设置为 0。

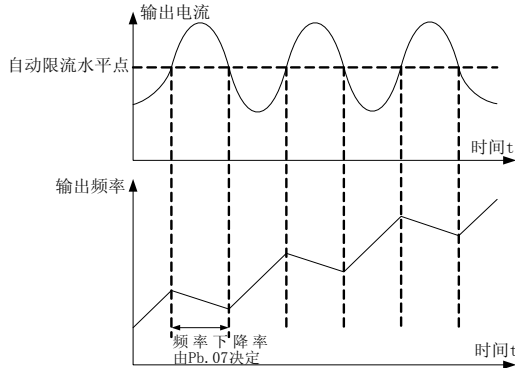
本机通讯地址在通讯网络中具有唯一性, 这是实现上位机与变频器点对点通讯的基础。

Hc.01	通讯波特率设置	0: 1200BPS 1: 2400BPS 2: 4800BPS 3: 9600BPS 4: 19200BPS 5: 38400BPS	无	3	√
-------	---------	--	---	---	---

此参数用来设定上位机与变频器之间的数据传输速率。注意, 上位机与变频器设定的波特率必须一致, 否则, 通讯无法进行。波特率越大, 通讯速度越快。

Hc.02	数据位校验设置	0: 无校验 (N, 8, 1) for RTU 1: 偶校验 (E, 8, 1) for RTU 2: 奇校验 (O, 8, 1) for RTU 3: 无校验 (N, 8, 2) for RTU 4: 偶校验 (E, 8, 2) for RTU 5: 奇校验 (O, 8, 2) for RTU 6: 无校验 (N, 7, 1) for ASCII 7: 偶校验 (E, 7, 1) for ASCII 8: 奇校验 (O, 7, 1) for ASCII 9: 无校验 (N, 7, 2) for ASCII 10: 偶校验 (E, 7, 2) for ASCII 11: 奇校验 (O, 7, 2) for ASCII 12: 无校验 (N, 8, 1) for ASCII 13: 偶校验 (E, 8, 1) for ASCII 14: 奇校验 (O, 8, 1) for ASCII 15: 无校验 (N, 8, 2) for ASCII 16: 偶校验 (E, 8, 2) for ASCII 17: 奇校验 (O, 8, 2) for ASCII	无	0	√
-------	---------	--	---	---	---

上位机与变频器设定的数据格式必须一致, 否则, 通讯无法进行。

Hc.03	通讯应答延时	0 ~ 200ms	毫秒	5ms	√
-------	--------	-----------	----	-----	---

应答延时; 是指变频器数据接受结束到向上位机发送应答数据的中间间隔时间。如果应答延时小于系统处理时间, 则应答延时以系统处理时间为准, 如应答延时长于系统处理时间, 则系统处理完数据后, 要延迟等待, 直到应答延迟时间到, 才向上位机发送数据。

Hc.04	通讯超时故障时间	0.0 (无效), 0.1 ~ 100.0s	秒	0.0s	√
-------	----------	------------------------	---	------	---

当该功能码设置为 0.0s 时，通讯超时时间参数无效。当该功能码设置成有效值时，如果一次通讯与下一次通讯的间隔时间超出通讯超时时间，系统将报通讯故障错误 (CE)。

通常情况下，都将其设置成无效。如果在连续通讯的系统中，设置该参数，可以监视通讯状况。

Hc.05	传输错误处理	0: 报警并自由停车 1: 不报警并继续运行 2: 不报警按停机方式停机 (仅通讯控制方式下) 3: 不报警按停机方式停机 (所有控制方式下)	无	1	√
-------	--------	--	---	---	---

变频器在通讯异常情况下可以通过设置保护动作选择以屏蔽故障告警和停机，保持继续运行。

Hc.06	传输回应处理	0: 写操作有回应 1: 写操作无回应	无	0	√
-------	--------	--------------------------------------	---	---	---

当该功能码设置为 0 时，变频器对上位机的读写命令都有回应。当该功能码设置为 1 时，变频器对上位机的仅对读命令都有回应，对写命令无回应，通过此方式可以提高通讯效率。

5.2.14 Hd 组补充参数区

Hd.00	抑制振荡低频阀值点	0 ~ 500	无	5	√
Hd.01	抑制振荡高频阀值点	0 ~ 500	无	100	√

但大多数电机在某些频率段运行时容易出现电流震荡，轻者电机不能稳定运行，重者会导致变频器过流。当 Hd.04=0 时使能抑制振荡，Hd.00, Hd.01 设置较小时，抑制振荡效果比较明显，电流增加较明显，设置较大时，抑制振荡效果比较弱。

Hd.02	抑制振荡限幅值	0 ~ 10000	无	5000	√
-------	---------	-----------	---	------	---

通过设定此参数值可以限制抑制振荡时的大电压提升值。

Hd.03	抑制振荡高低频分界频率	0.00Hz ~ H0.04 (最大频率)	无	12.50Hz	√
-------	-------------	--------------------------	---	---------	---

Hd.03 为功能码 Hd.00 和 Hd.01 的分界点。

Hd.04	抑制振荡	0: 抑制振荡有效 1: 抑制振荡无效	无	1	√
-------	------	--------------------------------------	---	---	---

0: 抑制振荡有效；

1: 抑制振荡无效。抑制振荡功能是针对 VF 控制而言的，普通电机在空载或轻载运行时经常会出现电流振荡现象，导致电机运行不正常，严重的会让变频器过流。Hd.04=0 时将使能抑制振荡功能，变频器将按照 Hd.00 ~ Hd.03 功能组的参数对电机出现的振荡进行抑制。

Hd.05	PWM 选择	0: PWM 模式 1 1: PWM 模式 2 2: PWM 模式 3	无	0	×
-------	--------	---	---	---	---

0: PWM 模式 1, 该模式为正常的 PWM 模式, 低频时电机噪音较小, 高频时电机噪音较大。

1: PWM 模式 2, 电机在该模式运行噪音较小, 但温升较高, 如选择此功能变频器需降额使用。

2: PWM 模式 3, 电机在该模式运行电机噪音较大, 但对电机振荡有较好的抑制作用。

Hd.06	转矩设定方式选择	0: 键盘设定转矩 (Hd.07) (100% 相对于 H3.07 转矩上限) 1: 模拟量 VIN 设定转矩 (100% 相对于 H3.07 转矩上限) 2: 模拟量 SIN 设定转矩 (100% 相对于 H3.07 转矩上限) 3: 模拟量 VIN+SIN 设定转矩 (100% 相对于 H3.07 转矩上限) 4: 多段转矩设定 (100% 相对于 H3.07 转矩上限) 5: 远程通讯设定转矩 (100% 相对于 H3.07 转矩上限)	无	0	√
Hd.07	键盘设定转矩	-100.0% ~ 100.0%	无	0	√

当 H0.00=2 时, 转矩控制有效。转矩控制时, 变频器按设定的转矩指令输出转矩, 输出频率受上限频率限制, 当负载速度大于设定的上限频率时, 变频器输出频率受限, 输出转矩将与设定转矩不相同。当做转矩控制时, Hd.06 所设定的转矩为转矩指令。当转矩指令为键盘设定时 (Hd.06 为 0 时), 通过设置功能码 Hd.07 来得到转矩指令。当转矩设定为负数时, 电机将反转。可通过多功能输入端子在转矩控制和速度控制之间进行切换。当变频器设定转矩大于负载转矩, 变频器输出频率会上升, 当变频器输出频率达到频率上限时, 变频器一直以上限频率运行。当变频器设定转矩小于负载转矩, 变频器输出频率会下降, 当变频器输出频率达到频率下限时, 变频器一直以下限频率运行。Hd.07 所设定的 100.0% 对应转矩上限设定, 即 H3.07, 调整 Hd.06、H3.07 均可改变转矩设定值。

注意: 当转矩控制有停机命令时, 自动切换到速度控制。

Hd.08	上限频率设定源选择	0: 键盘设定上限频率 (H0.05) 1: 模拟量 VIN 设定上限频率 (100% 对应最大频率) 2: 模拟量 SIN 设定上限频率 (100% 对应最大频率) 3: 多段设定上限频率 (100% 对应最大频率) 4: 远程通讯设定上限频率 (100% 对应最大频率)	无	0	√
-------	-----------	--	---	---	---

P56 五、功能参数说明

通过 H3.08 可以实现多种上限频率给定源选择。特别是在转矩控制时，可以通过改变上限频率的方法来改变变频器的输出频率。

Hd.09	限流动作选择	0: 限流一直有效 1: 限流恒速时无效	无	0	√
-------	--------	---------------------------------------	---	---	---

自动限流功能在加减速状态下始终有效，在自动限流动作时，输出频率可能会有所变化，所以对要求恒速运行时输出频率较稳定的场合，不宜使用自动限流功能。当自动限流有效时，由于限流水平的较低设置，可能会影响变频器过载能力。

5.2.15 HE 厂家参数区

该组为厂家参数组，用户不要尝试打开该组参数，否则会引起变频器不能正常运行或损坏。

六、选件 / 附件



图 6-1 外围设备和任选项连接示意图

说明！

标“*”者为任选项。

交流电抗器 ACL

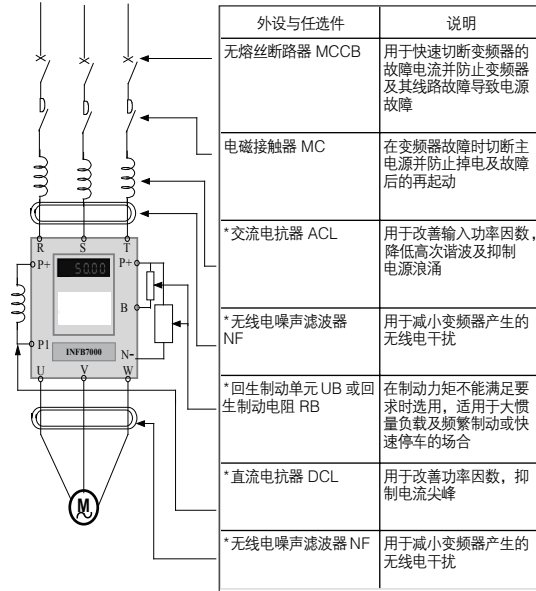
交流电抗器可抑制变频器输入电流的高次谐波，明显改善变频器的功率因数。建议在下列情况下使用交流电抗器：

- 变频器所用之处的电源容量与变频器容量之比为 10:1 以上。同一电源上接有可控硅负载或带有开关控制的功率因数补偿装置。
- 三相电源的电压不平衡度较大 ($\geq 3\%$)。

电压 (V)	功率 (kW)	电流 (A)	电感 (mH)	电压 (V)	功率 (kW)	电流 (A)	电感 (mH)
220	0.4	2.4	4.6	380	0.75	2.5	7.6
	0.75	4.5	2.4		1.5	4	4.8
	1.5	7	1.6		2.2	6	3.2
	2.2	11	1.0		4	9	2.0
	4	18	0.6		5.5	13	1.5
	5.5	22	0.5		7.5	17	1.2
	7.5	30	0.4		11	25	0.8
	11	42	0.27		15	32	0.6
	15	55	0.2		18.5	38	0.5
	18.5	70	0.16		22	45	0.42
	22	80	0.14		30	60	0.32
	30	110	0.1		37	75	0.26
	37	145	0.08		45	90	0.21
	45	180	0.06		55	110	0.18
	55	215	0.05		75	150	0.13
	75	285	0.04		93	170	0.11
	93	350	0.03		110	210	0.09
	110	415	0.03		132	250	0.08
					160	300	0.06
					200	380	0.05
			220	415	0.05		
			250	480	0.04		
			280	520	0.04		

表 6-1 常用规格的交流电抗器

直流电抗器 DCL

- 当电网容量远大于变频器容量或电源容量大于 1000KVA 时，或对改善电源功率因数要求较高时，需加装直流电抗器（如图 6-1 所示）。直流电抗器可与交流电抗器同时使用，对减小输入的高次谐波有明显效果。
- 本系列变频器 90KW 以上机种可配套使用直流电抗器。75KW 以下机种可在订货时提出以便 P1 端子配备变更。

电压 (V)	功率(KW)	电流(A)	电感(μH)	电压 (V)	功率(KW)	电流(A)	电感(μH)
220	11 ~ 15	75	450	380	11 ~ 15	40	1500
	18.5 ~ 30	150	200		18.5 ~ 30	75	600
	37 ~ 55	300	100		37 ~ 55	150	300
	75 ~ 90	420	40		75 ~ 90	220	200
	110	560	25		110 ~ 132	280	140
					160 ~ 200	370	110
					220	560	70
					250 ~ 280	740	55

表 6-2 常用规格的直流电抗器

无线电噪声滤波器 NF

无线电噪声滤波器用于抑制变频器产生的电磁干扰噪声的传导，也可抑制外界无线电干扰以及瞬时冲击、浪涌对本机的干扰。

电压 (V)	电机功率 (kW)	电压 (V)	电机功率 (kW)	滤波器型号	滤波器主要参数					
					共模输入损耗dB			差模输入损耗dB		
					0.1 MHz	1 MHz	30 MHz	0.1 MHz	1 MHz	30 MHz
220	0.4 ~ 0.75	380	0.75 ~ 1.5	DL-5EBT1	75	85	55	55	80	60
	1.5 ~ 2.2		2.2 ~ 4	DL-10EBT1	70	85	55	45	80	60
	4 ~ 5.5		5.5 ~ 7.5	DL-20EBT1	70	85	55	45	80	60
	7.5		11 ~ 15	DL-35EBT1	70	85	50	40	80	60
	11 ~ 15		18.5 ~ 22	DL-50EBT1	65	85	50	40	80	50
	18.5 ~ 22		30 ~ 37	DL-80EBT1	50	75	45	60	80	50
	30		45	DL-100EBK1	50	70	50	60	80	50
	37		55 ~ 75	DL-150EBK1	50	70	50	60	70	50
	45 ~ 55		93 ~ 110	DL-200EBK1	50	70	60	60	70	50

表 6-3 常用的三相三线制无线电噪声滤波器

P60 六、选件 / 附件

在对防止无线电干扰要求较高及要求符合 CE、UL、CSA 标准的使用场合或变频器周围有抗干扰能力不足的设备等情况下，均应使用该滤波器。安装时应注意接线尽量缩短，滤波器亦应尽量靠近变频器或安装于机内（如图 6-1 所示）。

远方操作盘

本系列变频器的面板上均带有设计精巧、使用方便的操作盘。在用户希望将操作盘外引到机外其它地方时，可购买加长线，只需在订货时提出即可。因操作盘与主机间采用串行通讯方式，因此用户可将操作盘移至距主机 10m 以内的地方，若需更大距离，可向供应商或本公司购买远方操作盘。

再生制动单元 UB 及再生制动电阻 RB

本系列机型 11kW 及以下均内置再生制动功能，如需增加制动力矩，仅需外接制动电阻。15kW 以上机型均无该功能，如需增加制动力矩，需外接制动单元。制动力矩为 100% 时，常用规格的制动电阻阻值及功率参照下表：

电压(V)	电机功率(KW)	电阻阻值(W)	电阻功率(KW)	电压(V)	电机功率(KW)	电阻阻值(W)	电阻功率(KW)
220	0.75	200	0.1	380			
	1.5	100	0.25		1.5	400	0.25
	2.2	75	0.25		2.2	250	0.25
	4	40	0.4		4	150	0.4
	5.5	30	0.5		5.5	100	0.5
	7.5	20	0.8		7.5	75	0.8
	11	13.6	2.25		11	50	1
	15	10	3		15	40	1.5
	18.5	8	4		18.5	30	4
	22	6.8	4.5		22	30	4
	30	5	6		30	20	6
	37	5	6		37	16	9
	45	6.8/2	9		45	13.6	9
	55	6.8/2	9		55	20/2	12
	75	6.8/3	13.5		75	13.6/2	18
	90	6.8/3	13.5		90	20/3	18
	110	6.8/4	18		110	20/3	18
				132	20/4	24	
				160	13.6/4	36	
				200	13.6/5	45	
				220	13.6/5	45	
				250	13.6/6	54	
				280	13.6/6	54	

表 6-4 常用制动电阻阻值及功率

漏电保护器

因为变频器内部、电机内部及输入、输出引线均存在对地静电电容，又因本系列变频器为低噪声型，所使用的载波频率较高，因此变频器对地漏电流较大，大容量机种更为明显，有时甚至会导致保护电路误动作。遇到上述问题时，除适当降低载波频率，缩短引线外，还应安装漏电保护器。使用漏电保护器时，应注意以下几点：

- 漏电保护器应设于变频器的输入侧，置于 MCCB(无熔丝断路器) 之后较为合适(如图 6-1 所示)。
- 漏电保护器的动作电流应大于该线路在工频电源下不使用变频器时漏电流(线路、无线电噪声滤波器、电机等漏电流的总和)的 10 倍。

七、故障检查与排除

7.1 故障信息及排除方法

故障代码	故障类型	可能的故障原因	处理对策
E001	逆变单元 U 相故障	1. 加速太快 2. 该相 IGBT 内部损坏 3. 干扰引起误动作 4. 接地是否良好	1. 增大加速时间 2. 寻求支援 3. 检查外围设备是否有 强干扰源
E002	逆变单元 V 相故障		
E003	逆变单元 W 相故障		
E004	加速运行 过电流	1. 加速太快 2. 电网电压偏低 3. 变频器功率偏小	1. 增大加速时间 2. 检查输入电源 3. 选用功率大一档的变 频器
E005	减速运行 过电流	1. 减速太快 2. 负载惯性转矩大 3. 变频器功率偏小	1. 增大减速时间 2. 外加合适的能耗制动 组件 3. 选用功率大一档的变 频器
E006	恒速运行 过电流	1. 负载发生突变或异常 2. 电网电压偏低 3. 变频器功率偏小	1. 检查负载或减小负载 的突变 2. 检查输入电源 3. 选用功率大一档的变 频器
E007	加速运行 过电压	1. 输入电压异常 2. 瞬间停电后，对旋转中电机 实施再启动	1. 检查输入电源 2. 避免停机再启动
E008	减速运行 过电压	1. 减速太快 2. 负载惯量大 3. 输入电压异常	1. 增大减速时间 2. 增大能耗制动组件 3. 检查输入电源
E009	恒速运行 过电压	1. 输入电压发生异常变动 2. 负载惯量大	1. 安装输入电抗器 2. 外加合适的能耗制动 组件
E010	母线欠压	电网电压偏低	检查电网输入电源
E011	电机过载	1. 电网电压过低 2. 电机额定电流设置不正确 3. 电机堵转或负载突变过大 4. 大马拉小车	1. 检查电网电压 2. 重新设置电机额定电流 3. 检查负载，调节转矩提 升量 4. 选择合适的电机

七、故障检查与排除 P63

E012	变频器过载	<ol style="list-style-type: none"> 1. 加速太快 2. 对旋转的电机实施再启动 3. 电网电压过低 4. 负载过大 	<ol style="list-style-type: none"> 1. 增大加速时间 2. 避免停机再启动 3. 检查电网电压 4. 选择功率更大的变频
E013	输入侧缺相	输入 R、 S、 T 有缺相	<ol style="list-style-type: none"> 1. 检查输入电源 2. 检查安装配线
E014	输出侧缺相	U、 V、 W 缺相输出 (或负载三相严重不对称)	<ol style="list-style-type: none"> 1. 检查输出配线 2. 检查电机及电缆
E015	整流模块过热	<ol style="list-style-type: none"> 1. 变频器瞬间过流 2. 输出三相有相间或接地短路 3. 风道堵塞或风扇损坏 4. 环境温度过高 	<ol style="list-style-type: none"> 1. 参见过流对策 2. 重新配线 3. 疏通风道或更换风扇 4. 降低环境温度
E016	逆变模块过热	<ol style="list-style-type: none"> 5. 控制板连线或插件松动 6. 辅助电源损坏, 驱动电压欠压 7. 功率模块桥臂直通 8. 控制板异常 	<ol style="list-style-type: none"> 5. 检查并重新连接 6. 寻求服务 7. 寻求服务 8. 寻求服务
E017	外部故障	SI 外部故障输入端子动作	检查外部设备输入
E018	通讯故障	<ol style="list-style-type: none"> 1. 波特率设置不当 2. 采用串行通信的通信错误 3. 通讯长时间中断 	<ol style="list-style-type: none"> 1. 设置合适的波特率 2. 按 STOP/RST 键复位, 寻求服务 3. 检查通讯接口配线
E019	电流检测电路故障	<ol style="list-style-type: none"> 1. 控制板连接器接触不良 2. 辅助电源损坏 3. 霍尔器件损坏 4. 放大电路异常 	<ol style="list-style-type: none"> 1. 检查连接器, 重新插线 2. 寻求服务 3. 寻求服务 4. 寻求服务
E020	电机自学习故障	<ol style="list-style-type: none"> 1. 电机容量与变频器容量不匹配 2. 电机额定参数设置不当 3. 自学习出的参数与标准参数偏差过大 4. 自学习超时 	<ol style="list-style-type: none"> 1. 更换变频器型号 2. 按电机铭牌设置额定参数 3. 使电机空载, 重新辨识 4. 检查电机接线, 参数设置
E021	EEPROM 读写故障	<ol style="list-style-type: none"> 1. 控制参数的读写发生错误 2. EEPROM 损坏 	<ol style="list-style-type: none"> 1. 按 STOP/RST 键复位, 寻求服务 2. 寻求服务
E022	PID 反馈断线故障	<ol style="list-style-type: none"> 1. PID 反馈断线 2. PID 反馈源消失 	<ol style="list-style-type: none"> 1. 检查 PID 反馈信号线 2. 检查 PID 反馈源
E023	制动单元故障	<ol style="list-style-type: none"> 1. 制动线路故障或制动管损坏 2. 外接制动电阻阻值偏小 	<ol style="list-style-type: none"> 1. 检查制动单元, 更换新制动管 2. 增大制动电阻

7.2 常见故障及其处理方法

变频器使用过程中可能会遇到下列故障情况，请参考下述方法进行简单故障分析：

上电无显示：

用万用表检查变频器输入电源是否和变频器额定电压相一致。如果电源有问题请检查并排除。检查三相整流桥是否完好。若整流桥已炸开，请寻求服务。

检查 CHARGE 灯是否点亮。如果此灯没有亮，故障一般集中在整流桥或缓冲电阻上，若此灯已亮，则故障可能在开关电源部分。请寻求服务。

上电后电源空气开关跳开：检查输入电源之间是否有接地或短路情况，排除存在问题。检查整流桥是否已经击穿，若已损坏，寻求服务。

变频器运行后电机不转动：

检查 U、V、W 之间是否有均衡的三相输出。若有，则为电机线路或自身损坏，或电机因机械原因堵转。请排除。可有输出但三相不均衡，应该为变频器驱动板或输出模块损坏，请寻求服务。若没有输出电压，可能会是驱动板或输出模块损坏，请寻求服务。

上电变频器显示正常，运行后电源空气开关跳开：检查输出模块之间相间是否存在短路情况。若是，请寻求服务。

检查电机引线之间是否存在短路或接地情况。若有，请排除。

若跳闸是偶尔出现而且电机和变频器之间距离比较远，则考虑加输出交流电抗器。

八、通讯协议

INFB7000 系列变频器，提供 RS485 通信接口，采用国际标准的 ModBus 通讯协议进行的主从通讯。用户可通过 PC/PLC、控制上位机等实现集中控制（设定变频器控制命令、运行频率、相关功能码参数的修改，变频器工作状态及故障信息的监控等），以适应特定的应用要求。

8.1 协议内容

该 Modbus 串行通信协议定义了串行通信中异步传输的帧内容及使用格式。其中包括：主机轮询及广播帧、从机应答帧的格式；主机组织的帧内容包括：从机地址（或广播地址）、执行命令、数据和错误校验等。从机的响应也是采用相同的结构，内容包括：动作确认，返回数据和错误校验等。如果从机在接收帧时发生错误，或不能完成主机要求的动作，它将组织一个故障帧作为响应反馈给主机。

8.2 应用方式

INFB7000 系列变频器接入具备 RS232/RS485 总线的“单主多从”控制网络。

8.3 总线结构

(1) 接口方式

RS485 硬件接口

(2) 传输方式

异步串行，半双工传输方式。在同一时刻主机和从机只能有一个发送数据而另一个接收数据。数据在串行异步通信过程中，是以报文的形式，一帧一帧发送。

(3) 拓扑结构

单主机多从机系统。从机地址的设定范围为 1 ~ 247，0 为广播通信地址。网络中的每个从机的地址具有唯一性。这是保证 ModBus 串行通讯的基础。

8.4 协议说明

INFB7000 系列变频器通信协议是一种异步串行的主从 ModBus 通信协议，网络中只有一个设备（主机）能够建立协议（称为“查询/命令”）。其他设备（从机）只能通过提供数据响应主机的“查询/命令”，或根据主机的“查询/命令”做出相应的动作。主机在此是指个人计算机（PC），工业控制设备或可编程逻辑控制器（PLC）等，从机是指 INFB7000 系列变频器或其他的具有相同通讯协议的控制设备。主机既能对某个从机单独进行通信，也能对所有从机发布广播信息。对于单独访问的主机“查询/命令”，从机都要返回一个信息（称为响应），对于主机发出的广播信息，从机无需反馈响应信息给主机。

8.5 通讯帧结构

INFB7000 系列变频器的 ModBus 协议通信数据格式分为 RTU (远程终端单元) 模式和 ASCII (American Standard Code for Information International Interchange) 模式两种进行通讯。

RTU 模式中，每个字节的格式如下：

编码系统：8 位二进制，

十六进制 0 ~ 9、A ~ F，

每个 8 位的帧域中，包含两个十六进制字符。

ASCII 模式中，每个字节的格式如下：

编码系统：通讯协议属于 16 进制，ASCII 的信息字符意义：

“0” … “9”，“A” … “F” 每个 16 进制代表每个 ASCII 信息，例如

字符	'0'	'1'	'2'	'3'	'4'	'5'	'6'	'7'	'8'	'9'
ASCII CODE	0x30	0x31	0x32	0x33	0x34	0x35	0x36	0x37	0x38	0x39
字符	'A'	'B'	'C'	'D'	'E'	'F'				
ASCII CODE	0x41	0x42	0x43	0x44	0x45	0x46				

字节的位：

包括起始位、7 或 8 个数据位、校验位和停止位。

字节位的描述如下表：

11-bit 字符帧：

起始位	Bit1	Bit2	Bit3	Bit4	Bit5	Bit6	Bit7	Bit8	无校验位 偶校验位 奇校验位	停止位
-----	------	------	------	------	------	------	------	------	----------------------	-----

10-bit 字符帧：

起始位	Bit1	Bit2	Bit3	Bit4	Bit5	Bit6	Bit7	无校验位 偶校验位 奇校验位	停止位
-----	------	------	------	------	------	------	------	----------------------	-----

在 RTU 模式中，新的总是以至少 3.5 个字节的传输时间静默，作为开始。在以波特率计算传输速率的网络上，3.5 个字节的传输时间可以轻松把握。紧接着传输的数据域依次为：从机地址、操作命令码、数据和 CRC 校验字，每个域传输字节都是十六进制的 0...9, A...F。网络设备始终监视着通讯总线的活动，即使在静默间隔时间内。当接收到第一个域（地址信息），每个网络设备都对该字节进行确认。随着最后一个字节的传输完成，又有一段类似的 3.5 个字节的传输时间间隔，用来表示本帧的结束，在此以后，将开始一个新帧的传送。

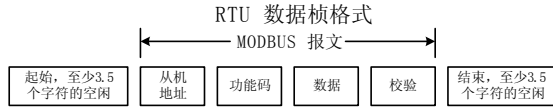

一个帧的信息必须以一个连续的数据流进行传输，如果整个帧传输结束前超过 1.5 个字节以上的间隔时间，接收设备将清除这些不完整的消息，并错误地认为随后一个字节是新一帧的地址域部分，同样的，如果一个新帧的开始与前一帧的间隔时间小于 3.5 个字节时间，接收设备将认为它是前一帧的继续，由于帧的错乱，最终 CRC 校验值不正确，导致通讯故障。

RTU 帧的标准结构:

帧头 START	T1-T2-T3-T4 (3.5 个字节的传输时间)
从机地址域 ADDR	通讯地址： 0 ~ 247 (十进制) (0 为广播地址)
功能域 CMD	03H：读从机参数； 06H：写从机参数
数据域 DATA (N-1) ... DATA (0)	2*N 个字节的数据，该部分为通讯的主要内容，也是通讯中，数据交换的核心。
CRC CHK 低位	检测值：CRC 校验值 (16BIT)
CRC CHK 高位	
帧尾 END	T1-T2-T3-T4 (3.5 个字节的传输时间)

在 ASCII 模式中，帧头为“:”(“0x3A”)，帧尾缺省为“CRLF”(“0x0D”“0x0A”)。在 ASCII 方式下，除了帧头和帧尾之外，其余的数据字节全部以 ASCII 码方式发送，先发送高 4 位元组，然后发送低 4 位元组。ASCII 方式下数据为 7 或 8 位长度。对于 ‘A’ ~ ‘F’，采用其大写字母的 ASCII 码。此时数据采用 LRC 校验，校验涵盖从从机地址到数据的信息部分。校验和等于所有参与校验数据的字符和(舍弃进位)的补码。

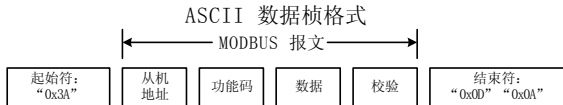

ASCII 帧的标准结构:

START	‘:’ (0x3A)
Address Hi	通讯地址:
Address Lo	8-bit 地址由 2 个 ASCII 码组合
Function Hi	功能码:
Function Lo	8-bit 地址由 2 个 ASCII 码组合
DATA (N-1) ... DATA (0)	数据内容: nx8-bit 数据内容由 2n 个 ASCII 码组合 n<=16, 最大 32 个 ASCII 码
LRC CHK Lo	LRC 检查码:
LRC CHK Hi	8-bit 检验码由 2 个 ASCII 码组合
END Hi	结束符:
END Lo	END Hi=CR (0x0D), END Lo=LF (0x0A)

8.6 命令码及通讯数据描述

11.6.1 命令码:03H(0000 0011), 读取 N 个字(Word)(最多可以连续读取 16 个字)
例如:从机地址为 01H 的变频器, 内存起始地址为 0004, 读取连续 2 个字, 则该帧的结构描述如下:

RTU 主机命令信息

START	T1-T2-T3-T4 (3.5 个字节的传输时间)
ADDR	01H
CMD	03H
起始地址高位	00H
起始地址低位	04H
数据个数高位	00H
数据个数低位	02H
CRC CHK 低位	85H
CRC CHK 高位	CAH
END	T1-T2-T3-T4 (3.5 个字节的传输时间)

RTU 从机响应信息

START	T1-T2-T3-T4 (3.5 个字节的传输时间)
ADDR	01H
CMD	03H
字节个数	04H
数据地址 0004H 高位	00H
数据地址 0004H 低位	00H
数据地址 0005H 高位	00H
数据地址 0005H 低位	00H
CRC CHK 低位	43H
CRC CHK 高位	07H
END	T1-T2-T3-T4 (3.5 个字节的传输时间)

ASCII 主机命令信息

START	‘:’
ADDR	‘0’
	‘1’
CMD	‘0’
	‘3’
起始地址高位	‘0’
	‘0’
起始地址低位	‘0’
	‘4’
数据个数高位	‘0’
	‘0’
数据个数低位	‘0’
	‘2’
LRC CHK Lo	‘F’
LRC CHK Hi	‘6’
END Lo	CR
END Hi	LF

ASCII 从机响应信息

START	‘:’
ADDR	‘0’
	‘1’
CMD	‘0’
	‘3’
字节个数	‘0’
	‘4’
数据地址: 0004H 高位	‘0’
	‘0’
数据地址: 0004H 低位	‘0’
	‘2’
数据地址: 0005H 高位	‘0’
	‘0’
数据地址: 0005H 低位	‘0’
	‘0’
LRC CHK Hi	‘F’
LRC CHK Lo	‘6’
END Lo	CR
END Hi	LF

8.6.2 命令码 : 06H (0000 0110), 写一个字 (Word)

例如：将 5000 (1388H) 写到从机地址 02H 变频器的 0008H 地址处。则该帧的结构描述如下：

RTU 主机命令信息

START	T1-T2-T3-T4 (3.5 个字节的传输时间)
ADDR	02H
CMD	06H
写数据地址高位	00H
写数据地址低位	08H
数据内容高位	13H
数据内容低位	88H
CRC CHK 低位	05H
CRC CHK 高位	6DH
END	T1-T2-T3-T4 (3.5 个字节的传输时间)

RTU 从机响应信息

START	T1-T2-T3-T4 (3.5 个字节的传输时间)
ADDR	02H
CMD	06H
写数据地址高位	00H
写数据地址低位	08H
数据内容高位	13H
数据内容低位	88H
CRC CHK 低位	05H
CRC CHK 高位	6DH
END	T1-T2-T3-T4 (3.5 个字节的传输时间)

ASCII 主机命令信息

START	‘.’
ADDR	‘0’
	‘2’
CMD	‘0’
	‘6’
写数据地址高位	‘0’
	‘0’
写数据地址低位	‘0’
	‘8’
数据内容高位	‘1’
	‘3’
数据内容低位	‘8’
	‘8’
LRC CHK Hi	‘5’
LRC CHK Lo	‘5’
END Lo	CR
END Hi	LF

ASCII 从机响应信息

START	‘:’
ADDR	‘0’
	‘2’
CMD	‘0’
	‘6’
写数据地址高位	‘0’
	‘0’
写数据地址低位	‘0’
	‘8’
数据内容高位	‘1’
	‘3’
数据内容低位	‘8’
	‘8’
LRC CHK Hi	‘5’
LRC CHK Lo	‘5’
END Lo	CR
END Hi	LF

8.6.3 通讯帧错误校验方式

帧的错误校验方式主要包括两个部分的校验，即字节的位校验（奇/偶校验）和帧的整个数据校验（CRC 校验或 LRC 校验）。

8.6.3.1 字节位校验

用户可以根据需要选择不同的位校验方式，也可以选择无校验，这将影响每个字节的校验位设置。

偶校验的含义：在数据传输前附加一位偶校验位，用来表示传输的数据中“1”的个数是奇数还是偶数，为偶数时，校验位置为“0”，否则置为“1”，用以保持数据的奇偶性不变。

奇校验的含义：在数据传输前附加一位奇校验位，用来表示传输的数据中“1”的个数是奇数还是偶数，为奇数时，校验位置为“0”，否则置为“1”，用以保持数据的奇偶性不变。

例如，需要传输“11001110”，数据中含5个“1”，如果用偶校验，其偶校验位为“1”，如果用奇校验，其奇校验位为“0”，传输数据时，奇偶校验位经过计算放在帧的校验位的位置，接收设备也要进行奇偶校验，如果发现接受的数据的奇偶性与预置的不一致，就认为通讯发生了错误。

8.6.3.2 CRC 校验方式 —— CRC(Cyclical Redundancy Check) :

使用 RTU 帧格式，帧包括了基于 CRC 方法计算的帧错误检测域。CRC 域检测了整个帧的内容。CRC 域是两个字节，包含 16 位的二进制值。它由传输设备计算后加入到帧中。接收设备重新计算收到帧的 CRC，并与接收到的 CRC 域中的值比较，如果两个 CRC 值不相等，则说明传输有错误。

CRC 是先存入 0xFFFF，然后调用一个过程将帧中连续的 6 个以上字节与当前寄存器中的值进行处理。仅每个字符中的 8Bit 数据对 CRC 有效，起始位和停止位以及奇偶校验位均无效。

CRC 产生过程中，每个 8 位字符都单独和寄存器内容相异或（XOR），结果向最低有效位方向移动，最高有效位以 0 填充。LSB 被提取出来检测，如果 LSB 为 1，寄存器单独和预置的值相异或，如果 LSB 为 0，则不进行。整个过程要重复 8 次。在最后一位（第 8 位）完成后，下一个 8 位字节又单独和寄存器的当前值相异或。最终寄存器中的值，是帧中所有的字节都执行之后的 CRC 值。

CRC 的这种计算方法，采用的是国际标准的 CRC 校验法则，用户在编辑 CRC 算法时，可以参考相关标准的 CRC 算法，编写出真正符合要求的 CRC 计算程序。

现在提供一个 CRC 计算的简单函数给用户参考（用 C 语言编程）：

```
unsigned int crc_cal_value(unsigned char *data_value,unsigned char data_
length)
{
int i;
unsigned int crc_value=0xffff;
while(data_length-->0)
{
crc_value^=*data_value++;
for(i=0;i<8;i++)
{
if(crc_value&0x0001)crc_value=(crc_value>>1)^0xa001;
else crc_value=crc_value>>1;
}
}
return(crc_value);
}
```

在阶梯逻辑中，CKSM 根据帧内容计算 CRC 值，采用查表法计算，这种方法程序简单，运算速度快，但程序所占用 ROM 空间较大，对程序空间有要求的场合，请谨慎使用。

8.6.3.3 ASCII 模式的校验（LRC Check）

校验码（LRC Check）由 Address 到 Data Content 结果加起来的结果，例如上面 8.6.2 通讯信息的的校验码：0x02+0x06+0x00+0x08+0x13+0x88=0xAB，然后取 2 的补码 =0x55。

8.6.4 通信数据地址的定义

该部分是通信数据的地址定义，用于控制变频器的运行、获取变频器状态信息及变频器相关功能参数设定等。

功能码参数地址表示规则

以功能码序号为参数对应寄存器地址，但要转换成十六进制，如 H5.05 的序号为 58，则用十六进制表示该功能码地址为 003AH。

高、低字节的范围分别为：高位字节——00 ~ 01；低位字节——00 ~ FF。

注意：HE 组：为厂家设定参数，既不可读取该组参数，也不可更改该组参数；有些参数在变频器处于运行状态时，不可更改；有些参数不论变频器处于何种状态，均不可更改；更改功能码参数，还要注意参数的设定范围，单位，及相关说明。

另外，由于 EEPROM 频繁被存储，会减少 EEPROM 的使用寿命，对于用户而言，有些功能码在通讯的模式下，无须存储，只需更改片内 RAM 中的值就可以满足使用要求。要实现该功能，只要把对应的功能码地址最高位由 0 变成 1 就可以实现。如：功能码 H0.07 不存储到 EEPROM 中，只修改 RAM 中的值，可将地址设置为 800CH；该地址只能用作写片内 RAM 时使用，不能用做读的功能，如做读为无效地址。其他功能的地址说明：

功能说明	地址定义	数据意义说明	R/W特性
通讯控制命令	1000H	0001H：正转运行	W/R
		0002H：反转运行	
		0003H：正转点动	
		0004H：反转点动	
		0005H：停机	
		0006H：自由停机（紧急停机）	
		0007H：故障复位	
		0008H：点动停止	
变频器状态	1001H	0001H：正转运行中	R
		0002H：反转运行中	
		0003H：变频器待机中	
		0004H：故障中	
通讯设定值地址	2000H	通信设定值范围（-10000 ~ 10000） 注意：通信设定值是相对值的百分数（-100.00% ~ 100.00%），可做通信写操作。当作为频率源设定时，相对的是最大频率（H0.04）的百分数；当作为 PID 给定或者反馈时，相对的是 PID 的百分数。其中，PID 给定值和 PID 反馈值，都是以百分数的形式进行 PID 计算的。	W/R

运行 / 停机参数地址说明	3000H	运行频率	R
	3001H	设定频率	R
	3002H	母线电压	R
	3003H	输出电压	R
	3004H	输出电流	R
	3005H	运行转速	R
	3006H	输出功率	R
	3007H	输出转矩	R
	3008H	PID 给定值	R
	3009H	PID 反馈值	R
	300AH	端子输入标志状态	R
	300BH	端子输出标志状态	R
	300CH	模拟量 AI1 值	R
		300DH	模拟量 AI2 值
300EH		保留	R
300FH		保留	R
3010H		保留	R
3011H		保留	R
3012H		多段速当前段数	R
变频器故障地址	5000H	故障信息代码与功能码菜单中故障类型的序号一致，只不过该处给上位机返回的是十六进制的数据，而不是故障字符。	R
ModBus 通讯故障地址	5001H	0000H：无故障 0001H：密码错误 0002H：命令码错误 0003H：CRC 校验错误 0004H：非法地址 0005H：非法数据 0006H：参数更改无效 0007H：系统被锁定 0008H：变频器忙（EEPROM 正在存储中）	R

8.6.5 错误通讯时的额外响应

当变频器通讯连接时，如果产生错误，此时变频器会响应错误码并将按固定的格式回应给主控系统，让主控系统知道有错误产生。变频器通讯无论命令码为“03”或是“06”，变频器的故障回复的命令字节均按“06”进行回复，并且数据地址固定为 0x5001。

例如：

RTU 从机故障回应信息

START	T1-T2-T3-T4 (3.5 个字节的传输时间)
ADDR	01H
CMD	06H
故障返回地址高位	50H
故障返回地址低位	01H
错误码高位	00H
错误码低位	05H
CRC CHK 低位	09H
CRC CHK 高位	09H
END	T1-T2-T3-T4 (3.5 个字节的传输时间)

ASCII 从机故障回应信息

START	‘.’
ADDR	‘0’
	‘1’
CMD	‘0’
	‘6’
故障返回地址高位	‘5’
	‘0’
故障返回地址低位	‘0’
	‘1’
错误码高位	‘0’
	‘0’
错误码低位	‘0’
	‘5’
LRC CHK Hi	‘A’
LRC CHK Lo	‘3’
END Lo	CR
END Hi	LF

错误码的含义：

错误码	说明
1	密码错误
2	命令码错误
3	CRC 校验错误
4	非法地址
5	非法数据
6	参数更改无效
7	系统被锁定
8	变频器忙 (EEPROM 正在存储中)

I. Important Information

1.1. Logo and Definition of Safety Information

There are 3 logo definitions in this manual. Please fully understand the logos and definitions below, in compliance with the notes accordingly before go on reading the manual.



Danger

Indicating runnings that violate the requirements may cause death or serious injury accidents.



Prohibited

Indicating actions that are absolutely prohibited



Notice

Indicating matters that should be noticed during running.

1.2. Notice



Notice

- Installation environment should be of no rain, water droplets, vapor, dust or oily dirt; no corrosive or flammable gas and liquid; no metal particles or metal powders, etc.
- Converter should be installed inside the control cabinet. Ensure the control cabinet to have good ventilation with the outside world.
- Do not drop objects into the converter.
- The grounding should be reliable. The motor and converter should connect ground separately, and never connect ground in series.
- The control circuit wiring should be separate with power circuit wiring, to avoid possible interference.
- Signal wiring should not be too long, otherwise it will increase the common-mode interference.
- Do not touch internal components within 5 minutes after power off. It will be safe after the power is completely discharged.
- The environment should comply with the requirements in table 2-1.



Prohibited

- It is forbidden to connect alternate power to the output terminal U, V, W, otherwise it will cause damages to the converter.
- Do not switch load at the output terminal in the process of converter running.
- Never ever touch high voltage terminal inside the converter, in protection against electric shock.
- No live-line work.
- Re-install all the protective covers before power on the converter, in protection against electric shock.
- Only professional personnel is permitted to maintain, inspect or change components.

1.3. Servicing and Maintenance



Notice

- Clean the cooling fan regularly, and inspect if or not it is in normal running; Clean the dust accumulated in the cleaner.
- Inspect the input and output wiring of the converter regularly.
- Inspect if or not the terminal screws are secured. Inspect if or not the wiring are aging.

1.4. Scrap Notice



Danger

- Burning the electrolytic capacitor inside the converter may cause explosion.
- Burning circuit boards may cause poisonous gas.



Notice

- The converter should be disposed as industrial waste.

II. Product Overview

2.1. Name Description of Converter

A name plate is stuck at the right downside of the converter, indicating the converter type and rated value. The information on the name plate is shown in figure 2-1:

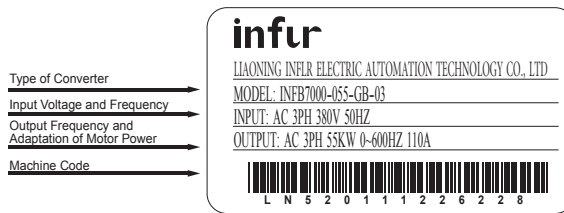

Figure 2-1

2.2. Type Description of Converter

The type description of the converter is shown in figure 2-2:

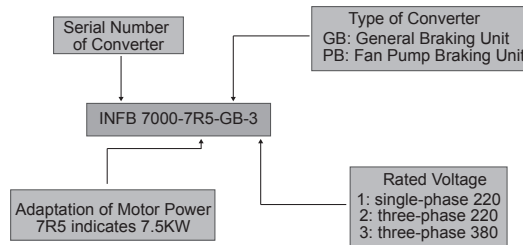

Figure 2-2

2.3. Three-Phase Inverter Series Models

Table 2-1

Type of Converter	Applicable Motor (KW)	Rated Current (A)
H5000-R75-GB-3	0.75KW	2.5A
H5000-1R5-GB-3	1.5KW	3.7A

H5000-2R2-GB-3	2.2KW	6.0A
H5000-3R7-GB-3	3.7KW	9.0A
H5000-5R5-GB-3	5.5KW	13A
H5000-7R5-GB-3	7.5KW	17A
H5000-011-GB-3	11KW	25A
H5000-015-GB-3	15KW	32A
H5000-018-GB-3	18.5KW	37A
H5000-022-G-3	22KW	45A
H5000-030-G-3	30KW	60A
H5000-037-G-3	37KW	75A
H5000-045-G-3	45KW	90A
H5000-055-G-3	55KW	110A
H5000-075-G-3	75KW	150A
H5000-090-G-3	90KW	170A
H5000-110-G-3	110KW	210A
H5000-132-G-3	132KW	250A
H5000-160-G-3	160KW	300A
H5000-185-G-3	185KW	340A
H5000-200-G-3	200KW	380A
H5000-220-G-3	220KW	420A
H5000-250-G-3	250KW	480A
H5000-280-G-3	280KW	540A
H5000-315-G-3	315KW	610A
H5000-350-G-3	350KW	680A
H5000-380-G-3	380KW	730A
H5000-400-G-3	400KW	800A

2.4. Technical Specification

Table 2-2

	Item	Specification
Input	Rated Voltage	380±15% V
	Rated Frequency	50/60Hz

II. Product Overview P81

Output	Output Voltage	0 ~ 380V
	Output Frequency	0.00 ~ 600.00Hz
	Carrier Frequency	0.5 ~ 15KHz
Control and Running	Control Method	V/F control, sensorless vector control, torque control
	Starting Torque	150% rated torque when at 0.50Hz
	Frequency Resolution	Digital setting 0.01Hz, analogy setting 0.1Hz
	Up-Down Speed	0.1~36000.0s random setting
	Overloadability	150% rated current, 60s
	On Off Control	Keyboard on-off control, external control terminal control, upper computer control
	Frequency Preset	Analogy preset, keyboard rise and fall keys preset, multistage speed preset, swing frequency running, upper computer preset
Protection	Standard Protection	Overcurrent, overvoltage, overload, undervoltage, overheating, stall, input and output phase loss protection
Display	Indicator	Running, positive reverse rotation, voltage, current, frequency indication
	LED Display	Display operating frequency, voltage, current, speed, fault code, parameter, functional code
Communication Interface	RS-485	Standard built-in
Use of Environment	Installation Site	Indoor, no corrosive gas, flammable gas, dust; no direct sunlight
	Altitude	Not higher than 1000m
	Ambient Temperature	10℃ ~ +50℃
	Ambient Humidity	Below 90%, no droplets condensation
	Vibration Strength	Less than 0.5g

III. Installation Wiring

3.1. Installation of Converter

H5000 has 2 types as wall hanging type and floor type. It should be installed with adequate distance for ventilation, shown as figure 3-1:

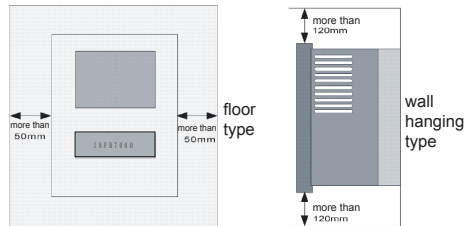

Figure 3-1

3.2. Standard Wiring Diagram

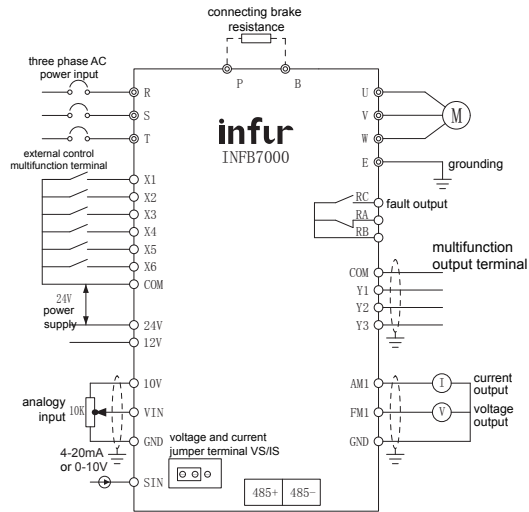

Figure 3-2

(Applicable to Models Below 18.5KW)

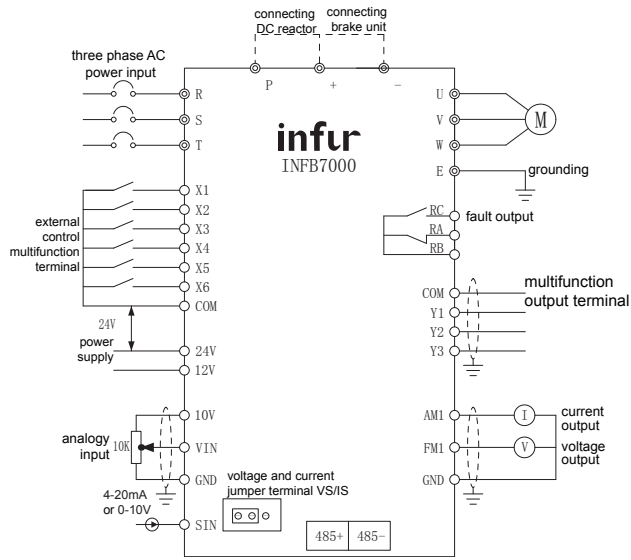
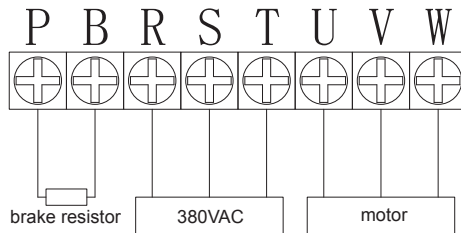

Figure 3-3

(Applicable to Models above 22KW)

3.3. Main Circuit Terminal and Description

3.3.1. Main Circuit Terminal Diagram:



(applicable to models below 2.2KW)

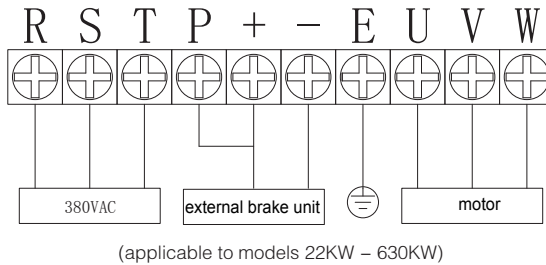
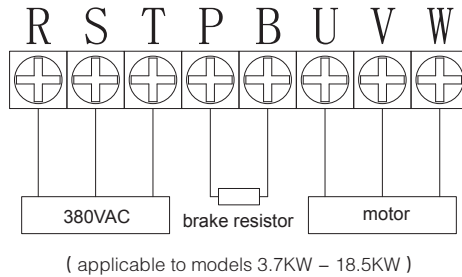

3.3.2. Main Circuit Terminal Function:

Table 3-1

Label	Name	Function
R, S, T	Converter Power Input Terminal	Connecting three phase AC power
+ (P)	External Brake Unit	+ (P) connecting the positive pole of external DC main circuit
- (N)		- (N) connecting the negative pole of external DC main circuit
+, B	External Braking Resistor	Connecting the 2 sides of braking resistor
P, +	External DC Reactor Terminal	Connecting the 2 sides of brake reactor
U, V, W	Converter Output Terminal	Connecting three phase AC motor

3.4. Control Terminal Description

3.4.1. Terminal Layout is shown as figure 3-3:

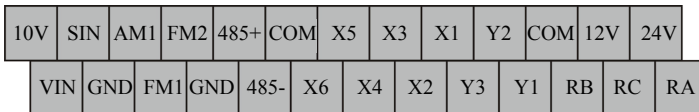

Figure 3-4

3.4.2. Control Terminal Function Description:

Type	Label	Name	Function
485 Communication	485+	RS485 Positive Terminal of Sending and Receiving	RS-485
	485-	RS485 Negative Terminal of Sending and Receiving	
Analogy Input	SIN	Analogy Input Terminal	0 ~ 10V / 4 ~ 20 毫安 (mA)
	VIN	Analogy Input Terminal	0 ~ 10V
	GND	Analogy Power Line Ground	The public line ground of analogy input and output
	10V	Analogy Power	10V power signal from the inside of converter
Programmable Multifunction Input Terminal	X1	Multifunction Terminal	Users can define the multifunction terminal with its public terminal as COM, and selected function setting through functional code H5.00~H5.05.
	X2		
	X3		
	X4		
	X5		
	X6		
Output Signal	Y1	Multifunction Terminal	Users define the function of Y1.Y2.Y3 as required, and select function setting through functional code H6.00~H6.02.
	Y2		
	Y3		
	COM	Power Line Ground	12V / 24V power line ground
	RA	Fault Relay	When fault occurs, RB and RC will be closed, and RB and RA will be disconnected. Shown as figure 3-2.
	RB		
	RC		
	24V	Relay and Power of Y Terminal	24V power signal from the inside of converter
	12V	12V Power	12V power signal from the inside of converter
	AM1	Analogy Output Signal	Between AM (FM) and GND, 1~10V signal can be output.
FM1			

IV. Operation

4.1. Panel Structure Description. Shown as figure 4–1

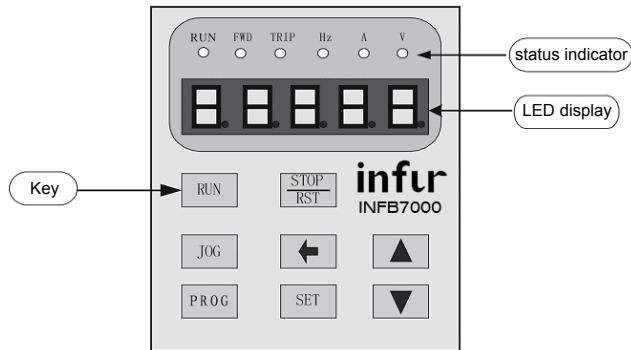





Figure 4–1

4.2. Keys Description, see table 4–1

表 4–1

Key	Name	Description
RUN	Runing	Push the key to start running
STOP RST	Stop/Reset	Push the key to stop running
JOG	Inching	Push and hold the key to start inching. Release the key to return to the status before inching.
SET	Setting	In the status of functional code editing, push the setting key, enter the status of parameter editing; push the setting again, save the adjusted parameters and return to status of functional code editing.
PROG	Programming	Push the programming key, enter the status of functional code editing; push the programming key again, return to the former status.

	Rising	In the process of parameter and functional code editing, used to increase the selected data position progressively; In the running process, in the status of frequency display, used to increase the frequency progressively.
	Descending	In the process of parameter and functional code editing, used to decrease the selected date position progressively; In the running process, in the status of frequency display, used to decrease the frequency progressively.
	Shifting	In the process of parameter and functional code editing, used to select data position.

4.3. Parameter Setting

The parameter setting process of this converter is shown as figure 4-2

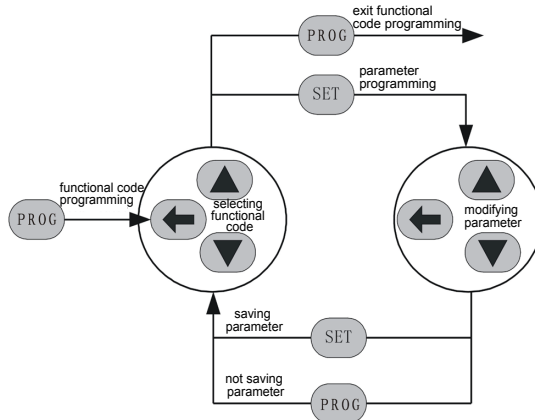

Figure 4-2

Specific Operating Process: push **PROG** to enter the status of functional code editing, and then select partition and area code by pushing **←**, **▲**, **▼** (selected bit glitters). Push **SET** to enter the status of parameter editing, display the current parameters, and then modify the parameter by **←**, **▲**, **▼** (selected bit glitters; if parameter has no glitter position, it indicates that the functional code cannot be modified). Complete the modification, push **SET** to save modified parameter to the converter and automatically return to the status of functional code editing. If you need to modify multiple parameters, repeat the operation above; If you want to return to the current status, in the status of parameter editing, push **PROG** and return.

4.4. LED Display Description

5 positions of LED display which can display set frequency, output frequency and other various monitoring data and warning codes.

4.5. Status Indicator Description

RUN	running indicator, lights on when running, lights off when stop
FWD	Positive reverse rotation indicator, lights on in positive running, lights off in reserve running
TRIP	Reserved
Hz	Unit of Frequency
A	Unit of Current
V	Unit of Voltage

4.5.1. Selflearning of Motor Parameter

Select the running mode with no PG vector control, before starting the converter, the nameplate parameters of the motor must be accurately input. H5000 series converter will match standard motor parameters according to the nameplate parameters; vector control is strongly depended on the motor parameters. To gain a better controlling performance, accurate parameters of the controlled motor must be obtained.

Operation of Motor Parameters Self-learning is shown as follows:

First, select (H0.01) the running command channel to keyboard command channel.

Then, input the actual parameters of the motor to the following parts:

H2.01: motor rated power; H2.02: motor rated frequency; H2.03: motor rated speed; H2.04: motor rated voltage;

H2.05: motor rated current

Caution: The motor must be disconnected with load. Otherwise, the motor parameter from self-learning may not be accurate. Setting H0.12 as 1. See the description of Functional Code H0.12 for detailed process of motor parameters selflearning. Then push **RUN** key on the keyboard panel, the converter will automatically compute the following parameters:

H2.06: motor stator resistance; H2.07: motor rotor resistance; H2.08: motor stator rotor inductance; H2.09: motor stator rotor transformer

H2.10: motor no load current; complete motor parameter self-learning.

4.6. Various Status of Converter

4.6.1. Initial Status of Power On

For the converter power on process, the system will first be initialization, and LED displays “H5000” . After completing the initialization, the converter will be standby.

4.6.2. Shutdown Status

In the status of shutdown or running, may display multiple parameters. Functional code H7.06 (running parameters), H7.07 (Shutdown parameters) selects whether or not to display by binary bit. For the definition of various bits, see H7.06 and H7.07 description of functional code.

In shutdown status, a total of 9 shutdown parameters can be selected whether or not to be displayed, which are: set frequency, bus voltage, switching input status, open collector output status, PID setting, PID feedback, analogy Input VIN voltage, analogy input SIN voltage, multistage speed section. Functional code H7.07 selects whether or not to display (by binary bit) . Push  key to switch selected parameters sequentially.

4.6.3. Motor Parameter Self-learning Status

For detailed information, see the description of functional code H0.12.

4.6.4. Running Status

In the running process, a total of 14 status parameters can be selected whether or not to be displayed, which are: running frequency, set frequency, bus voltage, output voltage, output current, output torque, PID setting, PID feedback, switching input status, open collector output status, open collector output status, analogy input VIN voltage, analogy input SIN voltage, multistage speed section. Functional code H7.06 selects whether or not to display (by binary bit). Push  key to switch the selected parameters sequentially.

4.6.5. Fault Status

H5000 series converter provides multiple fault information. For detailed information, see Fault and the Eliminating Method of H5000 Series Converter.

V. Function Parameter Description

5.1. Function Check Table:

Table 5-1

Functional code	Function Description	Setting Range and Description	Unit	factory worth	Modification
H0 Group Basic Parameter Area					
H0.00	Control Method Option	0: no speed sensor vector control 1: V/F control 2: torque control	N/A	0	×
H0.01	Start/Stop Signal Option	0: keyboard start and stop 1: terminal start and stop 2: communication start and stop	N/A	0	×
H0.02	Keyboard and Terminal Rising and Descending Setting	0: effective, with power off memory 1: effective, with no power off memory 2: no effect 3: the setting is effective in running, but clear when shutdown	N/A	0	√
H0.03	Frequency Setting Option	0: keyboard setting 1: analogy VIN setting 2: analogy SIN setting 3: VIN + SIN 4: multistage speed running setting 5: PID control setting 6: remote communication setting	N/A	0	√
H0.04	Maximum Output Frequency	10.00 ~ 600.00Hz	Hertz	50.00Hz	×
H0.05	Upper Limit of Running Frequency	H0.06 ~ H0.04	Hertz	50.00Hz	×
H0.06	Lower Limit of Running Frequency	0.00Hz ~ H0.05	Hertz	0.00	√

V. Function Parameter Description P91

H0.07	Keyboard Setting Frequency	0.00 Hz ~ H0.04	Hertz	50.00Hz	√
H0.08	Acceleration Time	0.1 ~ 3600.0s	second	10.0s	√
H0.09	Deceleration Time	0.1 ~ 3600.0s	second	10.0s	√
H0.10	Running Direction Option	0: positive running 1: reverse running 2: reverse rotation prohibited	N/A	0	×
H0.11	Carrier Frequency Setting	0.5 ~ 15.0kHz	KiloHertz	8.0 kHz	√
H0.12	Motor Parameter Identification	0: no operation 1: motor parameter identification 2: parameter static self-learning	N/A	0	×
H0.13	If or Not Return Default Value	0: no operation 1: return default value	N/A	0	×
H0.14	AVR Function Option	0: no effect 1: effective in full range 2: no effect only in deceleration	N/A	0	√
Group H1, On/Off Control Parameters Area					
H1.00	Starting Method Option	0: direct starting 1: starting after DC braking	N/A	0	×
H1.01	Direct Starting Frequency	0.00~10.00Hz	Hertz	0.00Hz	√
H1.02	Holding Time of Staring Frequency	0.0 ~ 50.0s	second	0.0	√
H1.03	Braking Current Before Starting	0.0 ~ 150.0%	%	0.0%	√
H1.04	Braking Time Before Starting	0.0 ~ 50.0s	second	0.0s	
H1.05	Shutdown Method Option	0: deceleration stop 1: free stop	N/A	0	√
H1.06	Starting Frequency of Shutdown Braking	0.00 ~ H0.04	Hertz	0.00Hz	√

P92 V. Function Parameter Description

H1.07	Waiting Time of Shutdown Braking	0.0 ~ 50.0s	second	0.0s	√
H1.08	Shutdown DC Braking Current	0.0 ~ 150.0	%	0.0	√
H1.09	Shutdown DC Braking Time	0.0 ~ 50.0s	second	0.0s	√
H1.10	Positive Reverse rotation Dead Time	0.0~3600.0s	second	0.0s	√
H1.11	Power On Terminal Running Protection	0 : invalid terminal running command when power on 1 : valid terminal running command when power on	N/A	0	√
H1.12	Reserved				
Group H2, Motor Parameters Area					
H2.00	Type of Converter	0 : G Model	N/A	0	×
H2.01	Motor Rated Power	0.4 ~ 900.0kW	KiloWatt	Model Set	×
H2.02	Motor Rated Frequency	0.01Hz ~ H0.04	Hertz	50.00Hz	×
H2.03	Motor Rated Speed	0 ~ 36000rpm	r/min	1400	×
H2.04	Motor Rated Voltage	0 ~ 460V	Voltage	380	×
H2.05	Motor Rated Current	0.1 ~ 2000.0A	Ampere	Model Set	×
H2.06	Motor Stator Resistance	0.001 ~ 65.535 Ω	ohm	Model set	√
H2.07	Motor Rotor Resistance	0.001 ~ 65.535 Ω	ohm	Model Set	√
H2.08	Motor Stator Rotor Inductance	0.1 ~ 6553.5mH	mH	Model Set	√
H2.09	Motor Stator Rotor Transformer	0.1 ~ 6553.5mH	mH	Model Set	√
H2.10	Motor No Load Current	0.01 ~ 655.35A	Ampere	Model Set	√
Group H3, Vector Control Group					

V. Function Parameter Description P93

H3.00	Speed Circulation Proportional Gain 1	0~100	N/A	20	√
H3.01	Speed Circulation Integral Time	0.01 ~ 10.00s	second	0.50s	√
H3.02	Low Frequency Switching	0.00Hz ~ H3.05	Hertz	5.00Hz	√
H3.03	Speed Circulation Proportional Gain 2	0 ~ 100	N/A	25	√
H3.04	Speed Circulation Integral Time	0.01 ~ 10.00s	second	1.00	√
H3.05	High Frequency Switching	H3.02 ~ H3.04	Hertz	10.00Hz	√
H3.06	VC Slip Compensation Coefficient	50 ~ 200%	%	100%	√
H3.07	Torque Upper Limit Setting	Converter Rated Current	%	150%	√
Group H4, V/F Control Group					
H4.00	V/F Curve Setting	0: straight line V/F curve 1: power of 2.0 of torque V/F	N/A	0	×
H4.01	Torque Lifting	0.0: (automatic) 0.1 ~ 30.0	%	0.0%	√
H4.02	Torque Lifting Cut-off	0.0 ~ 50.0% relative to the motor rated frequency	%	20.0%	×
H4.03	V/F Slip Compensation Limit	0.0 ~ 200.0%	%	100.0%	√
H4.04	Efficient Running Option	0: no action 1: automatic efficient running	N/A	0	√
Group H5, Input Terminal Group					
H3.05	High Frequency Switching	H3.02 ~ H3.04	Hertz	10.00Hz	√

P94 V. Function Parameter Description

H3.06	VC Slip Compensation Coefficient	50 ~ 200%	%	100%	√
H3.07	Torque Upper Limit Setting	Converter Rated Current	%	150%	√
Group H5. Input Terminal Group					
H5.00	X1 Terminal Function Option	0: no function 1: running in positive rotation	N/A	1	×
H5.01	X2 Terminal Function Option	2: reverse running 3: three wire running control	N/A	4	×
H5.02	X3 Terminal Function Option	4: positive inching 5: reverse inching 6: free shutdown 7: fault reset	N/A	7	×
H5.03	X4 Terminal Function Option	8: external fault input 9: frequency setting increment (UP)	N/A	0	×
H5.04	X5 Terminal Function Option	10: frequency setting decrement (Down) 11: frequency add and delete setting removal	N/A	0	×
H5.05	X6 Terminal Function Option	12: multistage terminal 1 13: multistage terminal 2 14: multistage terminal 3 15: time option of acceleration and deceleration 16: PID control pause 17: swing frequency pause (at the current frequency) 18: swing frequency reset (back to the central frequency) 19: prohibiting acceleration and deceleration 20: torque control prohibited 21: temporary removal of frequency add and delete setting 22~25: reserved	N/A	0	×
H5.06	Switching Capacity Wave Filtering Times	1 ~ 10	N/A	5	√
H5.07	Terminal Control Running Mode	0 : two wire control 1 1 : two wire control 2 2 : three wire control 3 3 : three wire control 2	N/A	0	×

V. Function Parameter Description P95

H5.08	Incremental Rate of Change of Terminal Rising and Descending Frequency	0.01 ~ 50.00Hz/s	Hertz/s	0.50Hz/s	√
H5.09	VIN Lower Limit	0.00V ~ 10.00V	Voltage	0.00V	√
H5.00	X1 Terminal Function Option	0: no function 1: running in positive rotation 2: reverse running 3: three wire running control 4: positive inching 5: reverse inching 6: free shutdown 7: fault reset 8: external fault input 9: frequency setting increment (UP) 10: frequency setting decrement (Down) 11: frequency add and delete setting removal 12: multistage terminal 1 13: multistage terminal 2 14: multistage terminal 3 15: time option of acceleration and deceleration 16: PID control pause 17: swing frequency pause (at the current frequency) 18: swing frequency reset (back to the central frequency) 19: prohibiting acceleration and deceleration 20: torque control prohibited 21: temporary removal of frequency add and delete setting 22-25: reserved	N/A	1	×
H5.01	X2 Terminal Function Option		N/A	4	×
H5.02	X3 Terminal Function Option		N/A	7	×
H5.03	X4 Terminal Function Option		N/A	0	×
H5.04	X5 Terminal Function Option		N/A	0	×
H5.05	X6 Terminal Function Option		N/A	0	×
H5.06	Switching Capacity Wave Filtering Times	1 ~ 10	N/A	5	√

P96 V. Function Parameter Description

H5.07	Terminal Control Running Mode	0: two wire control 1 1: two wire control 2 2: three wire control 3 3: three wire control 2	N/A	0	×
H5.08	Incremental Rate of Change of Terminal Rising and Descending Frequency	0.01 ~ 50.00Hz/s	Hertz/s	0.50Hz/s	√
H5.09	VIN Lower Limit	0.00V ~ 10.00V	Voltage	0.00V	√
H5.00	X1 Terminal Function Option	0: no function 1: running in positive rotation 2: reverse running 3: three wire running control	N/A	1	×
H5.01	X2 Terminal Function Option	4: positive inching 5: reverse inching 6: free shutdown 7: fault reset 8: external fault input 9: frequency setting increment (UP)	N/A	4	×
H5.02	X3 Terminal Function Option	10: frequency setting decrement (Down) 11: frequency add and delete setting removal 12: multistage terminal 1 13: multistage terminal 2 14: multistage terminal 3	N/A	7	×
H5.03	X4 Terminal Function Option	15: time option of acceleration and deceleration 16: PID control pause 17: swing frequency pause (at the current frequency)	N/A	0	×
H5.04	X5 Terminal Function Option	18: swing frequency reset (back to the central frequency) 19: prohibiting acceleration and deceleration	N/A	0	×
H5.05	X6 Terminal Function Option	20: torque control prohibited 21: temporary removal of frequency add and delete setting 22~25: reserved	N/A	0	×

V. Function Parameter Description P97

H5.06	Switching Capacity Wave Filtering Times	1 ~ 10	N/A	5	√
H5.07	Terminal Control Running Mode	0: two wire control 1 1: two wire control 2 2: three wire control 3 3: three wire control 2	N/A	0	×
H5.08	Incremental Rate of Change of Terminal Rising and Descending Frequency	0.01 ~ 50.00Hz/s	Hertz/s	0.50Hz/s	√
H5.09	VIN Lower Limit	0.00V ~ 10.00V	Voltage	0.00V	√
H5.10	Setting Corresponding to VIN Lower Limit	-100.0 ~ 100.0%	%	0.0%	√
H5.11	VIN Upper Limit	0.00V ~ 10.00V	Voltage	10.00V	√
H5.12	Setting Corresponding to VIN Upper Limit	-100.0 ~ 100.0%	%	100.0%	√
H5.13	VIN Input Wave Filtering Time	0.00s ~ 10.00s	second	0.10s	√
H5.14	SIN Lower Limit	0.00V ~ 10.00V	Voltage	0.00V	√
H5.15	Setting Corresponding to SIN Lower Limit	-100.0 ~ 100.0%	%	0.0%	√
H5.16	SIN Upper Limit	0.00V ~ 10.00V	Voltage	10.00V	√
H5.17	Setting Corresponding to SIN Upper Limit	-100.0 ~ 100.0%	%	100.0%	√
H5.18	SIN Input Wave Filtering Time	0.00s ~ 10.00s	second	0.10s	√
Group H6, Output Terminal Group					

P98 V. Function Parameter Description

H6.00	Y1 Output Option	0: no output 1: motor is running in positive rotation 2: motor is running in reverse rotation	N/A	1	√
H6.01	Y2 Output Option	3: fault output 4: frequency level detection FDT output	N/A	0	
H6.02	Y3 Output Option	5: frequency reaching 6: running in zero speed 7: upper limit of frequency reaching	N/A	0	√
H6.03	Relay Output Option	8: lower limit of frequency reaching 9~10: reserved	N/A	3	
H6.04	FM (AM) Output Option	0: running frequency 1: set frequency 2: running speed 3: output current 4: output voltage 5: output power 6: output torque 7: analogy VIN input value 8: analogy SIN input value 9~10: reserved	N/A	0	√
H6.05	FM (AM) Output Lower Limit	0.0 ~ 100.0%	%	0.0%	√
H6.06	FM(AM) Output Corresponding to Lower Limit	0.00V ~ 10.00V	Voltage	0.00V	√
H6.07	FM(AM) Output Upper Limit	0.0 ~ 100.0%	%	100.0%	√
H6.08	FM Output Corresponding to Upper Limit	0.00V ~ 10.00V	Voltage	10.00V	√
Group H7, Man-Machine Interface Group					
H7.00	User Password	0 ~ 65535	N/A	0	√
H7.01	Reserved				
H7.02	Reserved				

V. Function Parameter Description P99

H7.03	QUICK/JOG Key Function Seletion	0: inching running 1: switches of positive and reverse rotation 2: Removing UP/DOWN setting	N/A	0	×
H7.04	STOP/RST key Shutdown Function Option	0: only effective to the operational panel control 1: effective to both the operational panel and terminal control 2: both effective to the panel and communication control 3: effective to all control methods	N/A	0	√
H7.05	Keyboard Display Option	0: external keyboard priority 1: local and external keyboard display at the same time 2: local and external keyboard display at the same time, but only local keys are effective	N/A	0	√
H7.06	Parameter Option of Running Status Display	0 ~ 0x7FFF FE: running frequency Fd: set frequency FC: bus voltage Fb: output voltage FA: output current F9: running speed F8: output power F7: output torque F6: PID preset value F5: PID feedback value F4: input terminal status F3: output terminal status F2: analogy VS1 value F1: analogy SIN value F0: the current section of multistage speed	N/A	0xFF	√
H7.07	Parameter Option of Shutdown Status Display	1 ~ 0x1FFF FE: set frequency Fd: bus voltage FC: input terminal status Fb: output terminal status FA: PID preset value F9: PID feedback value F8: analogy VIN value F7: analogy SIN value	N/A	0xFF	√

P100 V. Function Parameter Description

		F6: the current section of multistage speed F5~F0: reserved			
H7.08	Rectifier Module Temperature	0 ~ 100.0°C	centigrade		
H7.09	Inverter Module Temperature	0 ~ 100.0°C	centigrade		
H7.10	Software Version		N/A	3.0	
H7.11	Local Accumulative Time	0 ~ 65535h	Hour	0	
H7.12	Type of the Last Two Faults	1: inverter unit U phase protection (E001) 2: inverter unit V phase protection (E002) 3: inverter unit W phase protection (E003) 4: accelerating overcurrent (E004) 5: decelerating overcurrent (E005) 6: constant speed overcurrent (E006) 7: acceleration overvoltage (E007) 8: deceleration overvoltage (E008) 9: constant speed overvoltage (E009)	N/A		
H7.13	Type of the Last Fault	10: bus undervoltage fault (E010) 11: motor overload (E011) 12: converter overload (E012) 13: input lateral lack of phase (E013) 14: output lateral lack of phase (E014) 15: rectifier module overheating (E015) 16: inverter module 17: external fault (E017) 18: communication fault (E018) 19: current detection fault (E019)	N/A		

V. Function Parameter Description P101

H7.14	Type of Existing Fault	20: motor self-learning fault (E020) 21: EEPROM operation fault (E021) 22: PID feedback disconnection fault (E022)	N/A		
H7.15	Running Frequency of Existing Fault	23: brake unit fault (E023) 24: reserved	Hertz		
H7.16	Output Current of Existing Fault		Ampere	0.0A	
H7.17	Bus Voltage of Existing Fault		Voltage	0.0V	
H7.18	Input Terminal Status of Existing Fault		N/A	0	
H7.19	Output Terminal Status of Existing Fault		N/A	0	√
Group H8, Enhanced Parameters Area					
H8.00	Acceleration Time 2	0.1 ~ 3600.0s	second	20.00s	√
H8.01	Deceleration Time 2		second	20.00s	√
H8.02	Inching Frequency	0.1 ~ 3600.0s	second	5.00Hz	√
H8.03	Inching Acceleration Time	0.1 ~ 3600.0s	second	20.00s	√
H8.04	Inching Deceleration Time	0.1 ~ 3600.0s	second	20.00s	√
H8.05	Jump Frequency	0.00 ~ H0.04	Hertz	0.00Hz	√
H8.06	Amplitude of Jump Frequency	0.00 ~ H0.04	Hertz	0.00Hz	√
H8.07	Amplitude of Swing Frequency	0.0 ~ 100.0% (relative set frequency)	%	0.0%	√
H8.08	Amplitude of Jump Frequency	(relative amplitude of swing frequency)	%	0.0%	√

P102 V. Function Parameter Description

H8.09	Rising Time of Swing Frequency	0.1 ~ 3600.0s	second	5.0s	√
H8.10	Descending Time of Swing Frequency	0.1 ~ 3600.0s	second	5.0s	√
H8.11	Fault Automatic Reset Times	0 ~ 3	N/A	0	√
H8.12	Interval Time Between Fault Automatic Resets	0.1 ~ 100.0s	second	1.0s	√
H8.13	FDT Level Detection Value	0.00 ~ H0.04	Hertz	50.00Hz	√
H8.14	FDT Lag Detection Value	0.0 ~ 100.0% (FDT level)	%	5.0%	√
H8.15	Frequency Reaching Detection Amplitude	0.0 ~ 100.0% (max. frequency)	%	0.0%	√
H8.16	Brake Valve Voltage	115.0 ~ 140.0% (standard bus voltage)	%	125.0%	√
H8.17	Speed Display Coefficient	0.1 ~ 999.9% Mechanical speed=120*running frequency*H8.17/motor pole number	%	100.0%	√
Group H9, PID Parameters Area					
H9.00	PID Reset Source Option	0: keyboard preset 1: analogy channel VIN preset 2: analogy SIN preset 3: remote communication preset 4: multistage preset	N/A	0	√
H9.01	Keyboard Preset PID	0.0% ~ 100.0%	%	0.0%	×
H9.02	PID Feedback Source Option	0: analogy channel VIN feedback 1: analogy channel SIN feedback 2: VIN+SIN feedback 3: remote communication feedback	N/A	0	√

V. Function Parameter Description P103

H9.03	PID Output Characteristic Option	0: PID output is positive characteristic 1: PID output is negative characteristic	N/A	0	√
H9.04	Proportional Gain (Kp)	0.00 ~ 100.00	N/A	1.00	√
H9.05	Integral Time (Ti)	0.01 ~ 10.00s	second	0.10s	√
H9.06	Differential Time (Td)	0.00 ~ 10.00s	second	0.00s	√
H9.07	Sampling Period (T)	0.01 ~ 100.00s	second	0.10s	√
H9.08	PID Control Deviation Limit	0.0 ~ 100.0%	%	0.0%	√
H9.09	Feedback Disconnected Detection Value	0.0 ~ 100.0%	%	0.0%	√
H9.10	Feedback Disconnected Detection Time	0.0 ~ 3600.0s	second	1.0s	√
Group HA, Multistage Speed Parameters Area					
HA.00	Multistage Speed 0	-100.0 ~ 100.0%	%	0.0%	√
HA.01	Multistage Speed 1	-100.0 ~ 100.0%	%	0.0%	√
HA.02	Multistage Speed 2	-100.0 ~ 100.0%	%	0.0%	√
HA.03	Multistage Speed 3	-100.0 ~ 100.0%	%	0.0%	√
HA.04	Multistage Speed 4	-100.0 ~ 100.0%	%	0.0%	√
HA.05	Multistage Speed 5	-100.0 ~ 100.0%	%	0.0%	√
HA.06	Multistage Speed 6	-100.0 ~ 100.0%	%	0.0%	√
HA.07	Multistage Speed 7	-100.0 ~ 100.0%	%	0.0%	√
Group HB, Protection and Fault Parameters Area					
HB.00	Motor Overload Protection Option	0: no protection 1: regular motor (with low speed compensation) 2: variable frequency motor (without low speed compensation)	N/A	1	×

P104 V. Function Parameter Description

HB.01	Overload Protection Current of Motor	20.0% ~ 120.0% (rated current of motor)	%	100.0%	√
HB.02	Unlocking Point of Instant Power down	70.0 ~ 110.0% (standard bus voltage)	%	80.0%	√
HB.03	Descending Rate of Instant Power Down Frequency	0.00Hz ~ H0.04	Hertz	0.00Hz	√
HB.04	Overvoltage Stall Protection	0: Forbid 1: allow	N/A	0	√
HB.05	Overvoltage Stall Protection Voltage	110 ~ 150%	%	120%	√
HB.06	Automatic Current Limiting Level	100 ~ 200%	%	200%	√
HB.07	Descending rate of Frequency during Current Limiting	0.00 ~ 100.00Hz/s	Hertz/s	00.00Hz/s	√
Group HC, 485 Parameters Area					
HC.00	Local Communication Address	1 ~ 247, 0 as	无	1	√
HC.01	Setting of Communication Baud Rate		无	3	√
HC.02	Data Bits Parity Setting	0: no parity (N, 8, 1) For RTU 1: even parity (E, 8, 1) for RTU 2: odd parity (O, 8, 1) for RTU 3: no parity (N, 8, 2) for RTU 4: even parity (E, 8, 2) for RTU	无	0	√
HC.0			N/A		

V. Function Parameter Description P105

		5: odd parity (O, 8, 2) for RTU 6: no parity (N, 7, 1) for ASCII 7: even parity (E, 7, 1) for ASCII 8: odd parity (O, 7, 1) for ASCII 9: no parity (N, 7, 2) for ASCII 10: even parity (E, 7, 2) for ASCII 11: odd parity (O, 7, 2) for ASCII 12: no parity (N, 8, 1) for ASCII 13: even parity (E, 8, 1) for ASCII 14: odd parity (O, 8, 1) for ASCII 15: no parity (N, 8, 2) for ASCII 16: even parity (E, 8, 2) for ASCII 17: odd parity (O, 8, 2) for ASCII			
HC.03	Communication Reponse Time-Delay	0 ~ 200ms	millisecond	5ms	√
HC.04	Communication Overtime Failure Time	0.0 (invalid), 0.1 ~ 100.0s	second	0.0s	√
HC.05	Transmission Error Processing	0: warning followed by free stop 1: no warning and continue running	N/A	1	√

P106 V. Function Parameter Description

		2: no warning and stop in shutdown mode (only in communication control mode) 3: no warning and stop in shutdown mode (in all control methods)			
HC.06	Transmission Response Processing	0: recording operation with response 1: recording operation without response	N/A	0	√
Group HD, Additional Parameters Area					
Hd.00	Oscillation Suppression Low Frequency Threshold Point	0 ~ 500	N/A	5	√
Hd.01	Oscillation Suppression High Frequency Threshold Point	0 ~ 500	N/A	100	√
Hd.02	Oscillation Suppression Amplitude Limiting Value	0 ~ 10000	N/A	5000	√
Hd.03	Oscillation Suppression Height Demarcation Frequency	0.00Hz ~ H0.04 (max frequency)	N/A	12.50Hz	√
Hd.04	Oscillation Suppression	0: effective oscillation suppression 1: ineffective oscillation suppression	N/A	1	√
Hd.05	PWM Option	0: PWM mode 1 1: PWM mode 2 2: PWM mode 3	N/A	0	×
Hd.06	Torque Setting Mode Option	0: keyboard set torque (Hd.07) (100% relative to H3.07 torque upper limit) 1: analogy VIN set torque (100% relative to H3.07 torque upper limit) 3: analogy VIN + SIN set torque (100% relative to H3.07 torque upper limit) 4: multistage torque setting (100% relative to H3.07 torque upper limit)	N/A	0	√

V. Function Parameter Description P107

Hd.07	Keyboard setting torque	-100.0% ~ 100.0%	N/A	0	√
Hd.08	Upper Frequency Setting Source Option	0: upper limit frequency of keyboard setting (H0.05) 1: upper limit frequency of analogy VIN setting (100% corresponding to the max frequency) 2: upper limit frequency of analogy SIN setting (100% corresponding to the max frequency) 3: upper limit frequency of multistage setting (100% corresponding to the max frequency) 4: upper limit frequency of remote communication setting (100% corresponding to the max frequency)	N/A	0	√
Hd.09	Option of Current Limiting Action	0: current limiting is effective all the time 1: current limiting has no effect at constant speed	N/A	0	√
Group PE, Factory Parameters Area					
HE.00	Factory Password	0 ~ 65535	N/A	0	√

5.2. Parameters Specification

5.2.1. H0 Basic Parameters Group

H0.00	Control Method Option	0: no speed sensor vector control 1: V/F control 2: torque control	N/A	0	×
-------	-----------------------	---	-----	---	---

Select the running mode of converter:

0: No PG Vector Control

Refers to open loop vector. Applicable to high performance general occasions with on installation of PG encoder, such as machine tools, centrifuge, wire drawing machine, injection molding machine and other loads.

One converter can only drive one motor.

1: V/F Control

Applicable to occasions without critical requirement of control accuracy, such as

P108 V. Function Parameter Description

fan, pumps and other loads. Also can be used in the occasion of one converter driving multiple motors.

Note: when selecting the vector control mode, the self-learning of motor parameters is required. Only by obtaining accurate motor parameters, the vector control can play its advantages. By adjusting the parameter of speed regulator, higher performance can be achieved.

2: Torque Control

	On/Off Signal Option	0: keyboard on/off 1: terminal on/off 2: communication control on/off	N/A		
--	----------------------	--	-----	--	--

Select On/Off signal of the Converter

The control command of converter include: start, stop, positive rotation, reverse rotation, inching, fault reset and so on.

0: Keyboard On/Off

Using RUN, STOP/RST buttons on the keyboard panel to execute the running command control. In the running status, if simultaneously push RUN and STOP/RST buttons, the converter will automaticall shutdown.

1: Terminal On/Off

Using positive rotation, reverse rotation, positive inching, reverse rotation inching of multifunction input terminals to execute the running command control.

2: Communication Command Channel

The upper computer executes the running command control through communication.

	Keyboard and Terminal Rising and Descending Setting	0: effective, with converter power off storage 1: effective, without converter power off storage 2: ineffective 3: effective when running, zero clearing when shutdown	N/A		
--	---	---	-----	--	--

Converter can set frequency through the keyboard “Λ” and “V” and terminal UP/DOWN (frequency setting increases progressively/frequency setting decreases progressively) function, the biggest authority of which is to combine with any other frequency setting channel. Primarily complete the output frequency of fine tuning converter in the process of debugging of the control system.

0: effective, with converter power off storage. Able to set frequency command, and when the converter is power off, it will save the set frequency value. When the converter is power on next time, it will automatically integrate with the current frequency.

1: effective, without converter power off storage. Able to set frequency command, but when the converter is power off, it will not save the set frequency value.

2: ineffective. The frequency value set by UP/DOWN function of keyboard and terminal will automatically be zero clearing, and the keyboard and terminal UP/DOWN setting will be ineffective.

3: In the process of running, the “^” and “v” as well as terminal UP/DOWN function settings are effective; the keyboard “^” and “v” as well as terminal UP/DOWN settings are to be zero clearing when shutdown.

Notice: when users return the default value of the converter, the frequency value set by the keyboard and terminal UP/DOWN function will be automatically zero clearing.

H0.03	Frequency Setting Option	0: keyboard setting 1: analogy VIN setting 2: analogy SIN setting 3: VIN +SIN 4: multistage speed running setting 5: PID control setting 6: remote communication setting	N/A	0	√
-------	--------------------------	---	-----	---	---

Select the converter preset frequency input channel. A total of 7 main preset frequency channels:

0: keyboard setting

By modifying the value of function code H0.07 “keyboard setting frequency” , keyboard setting is achieved.

H1: analogy VIN setting

2: analogy SIN setting

3: analogy VIN + SIN setting

Frequency is set by the analogy input terminal. INFB7000 series converter standard configuration provides 2 routes of analogy input terminals, among which VIN is 0~10V voltage input, and SIN may be 0~10V voltage input of 0 (4)~20mA current input. The current input and voltage input can be switched by jumper wire. 100% of analogy input setting corresponds to the maximum frequency (function code H0.04); -100.0% corresponds to the reverse maximum frequency (function code H0.04).

4: multistage speed running setting

Select the frequency setting method and the converter will be running in the mode of multistage speed. Required to set the parameters of Group H5 and HA group “multistage speed control group” to determine the relationship between the preset percentage and the preset frequency.

P110 V. Function Parameter Description

5: PID control setting

Select the parameter and the converter will be running in the mode of PID control setting. Now, set Group H9 “PID control group” .

The running frequency of the converter will be the frequency after the PID action.

For the meaning of PID preset source, preset quantity, feedback source and so on, refer to Group H9 “PID Function” description.

6: remote communication setting

Frequency command is preset by the upper computer through communication.

For detailed information, refer to 485 Communication Protocol

H0.04	Maximum Output Frequency	10.00 ~ 600.00Hz	Hertz	50.00Hz	×
-------	--------------------------	------------------	-------	---------	---

It is used to set the maximum output frequency of the converter. It is not only the basis of frequency setting but also the basis of the speed of acceleration/ deceleration.

H0.05	Upper Limit of Running Frequency	H0.06 ~ H0.04	Hertz	50.00Hz	√
-------	----------------------------------	---------------	-------	---------	---

The upper limit value of the converter. The value should be smaller or equal to the maximum output frequency.

H0.06	Lower Limit of Running Frequency	0.00Hz ~ H0.05	Hertz	0.00	√
-------	----------------------------------	----------------	-------	------	---

The lower limit value of the converter. When the set frequency is lower than the frequency of lower limit value, the converter will be running at the frequency of lower limit value, among which, max output frequency \geq upper limit frequency \geq lower limit frequency.

H0.07	Keyboard Setting Frequency	0.00 Hz ~ H0.04	Hertz	50.00Hz	√
-------	----------------------------	-----------------	-------	---------	---

When the frequency preset is selected as “keyboard setting” , the function code value will be the initial value of the digital frequency setting of the converter.

H0.08	Accelerating Time	0.1 ~ 3600.0s	second	10.0s	√
H0.09	Decelerating Time	0.1 ~ 3600.0s	second	10.0s	√

Acceleration time refers to the time the converter takes from 0Hz accelerating to the maximum output frequency (H0.04).

Deceleration time refers to the time the converter takes from the maximum output frequency (H0.04) decelerating to 0Hz.

Shown as follows:

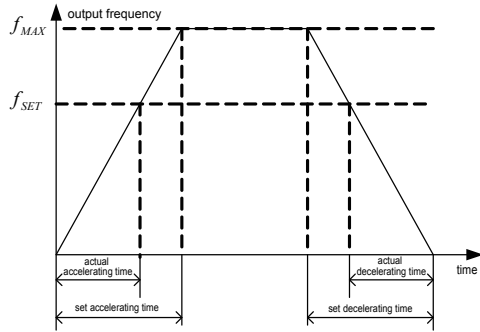

Figure 5-1 Acceleration and Deceleration Time Diagram

When the set frequency is equal to the maximum frequency, the actual acceleration/ deceleration time is in accord with the set acceleration/deceleration time.

When the set frequency is smaller than the maximum frequency, the actual acceleration/deceleration time is smaller than the set acceleration/deceleration time.

Actual acceleration/deceleration time = set acceleration/deceleration time × (set frequency / maximum frequency)

H0.10	Running Direction Option	0: positive running 1: reverse running 2: reverse rotation prohibited	N/A	0	×
-------	--------------------------	--	-----	---	---

0: positive running. After the converter power on, it will be running as the actual direction.

1: reverse running. By modifying the function code, the direction of the motor will be changed in the condition of not changing any other parameter. The effect is equivalent to the motor direction switching through the adjustment of any two wires of motor wires (U, V, W).

Note: After initiating the parameters, the direction of the converter will return to the former status. It should be used with caution in the occasion of prohibiting the change of motor direction after system debugging.

2: prohibiting the reverse running. The reverse running of the converter is prohibited. It is applicable to the specific occasions of prohibiting reverse running.

H0.11	Carrier Frequency Setting	1.0 ~ 15.0kHz	KiloHertz	8.0 kHz	√
-------	---------------------------	---------------	-----------	---------	---

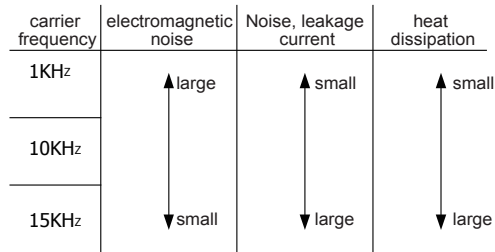

Figure 5-2 Diagram of the Impact of Carrier Frequency on the Environment

Table of Relationships Between Models and Carrier Frequency

Carrier Frequency Model	Highest Carrier Frequency kHz	Lowest Carrier Frequency kHz	Factory Value
0.75 ~ 15 kW	15	1	8
18.5 ~ 75 kW	8	1	4
90 ~ 400 kW	6	1	2

The function is mainly for reducing the noises from the running motor and the interferences from the outside.

Advantages of using high carrier frequency: ideal current wave, small current harmonics, quiet motor; disadvantages of using high carrier frequency: increasing switching loss, increasing temperature rise of converter; the converter output capability will be affected; with high carrier frequency, the converter should be derated to use; meanwhile, the leakage current rate of the converter will be increased and the electromagnetic interference from the outside will be increased. If using low carrier frequency, the situation would be just contrary to the above. But the low carrier frequency will cause unstable low frequency, torque reduction and even the occurrence of oscillation.

When delivered from the factory, the converter has already appropriately set the carrier frequency. Under normal circumstances, user doesn't need to modify the parameters.

H0.12	Self-learning of Motor Parameters	0: no operation 1: self-learning of motor parameters	N/A	0	×
-------	-----------------------------------	---	-----	---	---

0: no operation, i.e. prohibiting self-learning.

1: motor parameters self-learning

Before the motor parameters selflearning, the motor must be disconnected with load, and be in the zero load status. Confirm the motor is in the static status.

Before the motor parameters selflearning, correctly input the motor nameplate

V. Function Parameter Description P113

parameters (H2.01, H2.05), otherwise, there would not be correct result of motor parameters selflearning.

Before the motor parameters selflearning, appropriately set acceleration/ deceleration time (H0.08, H0.09) according to the strength of the motor inertia.

Set H0.12 to be 1 and push SET key, begin the motor parameters selflearning. Now, LED displays “-TUN-” and glitters. Then push RUN key to start the parameters selflearning. Now it displays “TUN-0” . After the motor runs, it will display “TUN-1” , and “RUN” glitters. When completed the motor parameters selflearning, it displays “-END-” , and finally displays back to the shutdown status interface. When “-TUN-” glitters, push PRG key to exit the parameters selflearning status.

In the process of paramters selflearning, to push STOP/RST key will also terminate the operation of parameters selflearning. Note that the start and stop of parameters selflearning can only be controlled through keyboard; after completing the parameters selflearning, the function code will automatically return to 0.

2: parameters static selflearning

In the process of motor parameters static selflearning, it is not necessary to disconnect the motor from load. Before the motor parameters selflearning, correctly input the motor nameplate parameters (H2.00-H2.04). When completing the selflearning, it will detect the stator resistance, rotor resistance and leakage inductance of the motor. But the mutual reductance and no-load current will not be detected. Users can input the corresponding function codes.

H0.13	If or Not Return Default Value	0: no operation 1: return default value	N/A	0	×
-------	--------------------------------	--	-----	---	---

H0.14	AVR function chooses	0: invalid 1: the whole distance effective 2: invalid just while decelerating	无	0	×
-------	----------------------	--	---	---	---

AVR function is the auto-regulation function of output voltage. When AVR function is ineffective, the output voltage will change with the input voltage (or direct current bus voltage); When AVR function is effective, the output voltage will not change with the input voltage (or DC bus voltage). The output voltage will be basically constant in the range of output capability.

Notice: When the motor decelerates to stop, closing AVR function of autostabizing will stop the motor in a shorter deceleration time, and the motor will not be overvoltage.

5.2.2 Group H1, On Off Control Parameters Area

H1.00	Starting Method Option	0: direct starting 1: starting with DC braking first 2: starting with speed tracking first	N/A	0	×
-------	------------------------	---	-----	---	---

0: direct start: Start with the frequency starting.

1: start after DC braking: DC braking first (pay attention to set parameters H1.03, H1.04), and then start the frequency and the motor. Applicable to the occasion that the small inertia load may cause reverse rotation.

2: start after speed tracking: The converter will first compute the speed and direction of the motor, and then be running from the current speed to the set frequency, to achieve smooth impact starting of the rotating motor. The method is applicable to the instantaneous power of and restart of big inertia load .

H1.01	Starting Frequency of Direct Starting	0.00 ~ 10.00Hz	N/A	0.00Hz	√
H1.02	Holding Time of Starting Frequency	0.0 ~ 50.0s	second	0.0	√

To set appropriate starting frequency may multiply the torque at start. Within the holding time of starting frequency (H1.02), the converter output frequency will be the starting frequency, and then running from the starting frequency to the targeting frequency. If the targeting frequency (frequency command) is smaller than the starting frequency, the converter will stop running and be at shutdown status. The starting frequency is not limited by the lower limit frequency.

The starting frequency is ineffective in the switching of positive and reverse rotation.

H1.03	Braking Current before Starting	0.0 ~ 150.0	%	0.0	√
H1.04	Braking Time before Starting	0.0 ~ 50.0s	N/A	0.0s	√

When starting, the converter will implement DC braking according to the set DC braking current before start. After the set DC braking time before start, it will start to accelerate. If the set DC braking time is 0, the DC braking will be ineffective.

The bigger the DC braking current is, the bigger the brake resistance will be. The DC braking current before start refers to the percentage relative to the rated current of the converter.

H1.05	Shutdown Method Option	0: deceleration stop 1: free stop		0	√
-------	------------------------	--	--	---	---

0: Deceleration Stop

When shutdown command is effective, the converter will decrease the output frequency according to the deceleration mode and defined acceleration time. The converter will shutdown when the frequency decreased to 0.

1: Free Stop

Effective as the shutdown command, the converter will immediately stop output. The load is free to stop by mechanical inertia.

H1.06	Starting Frequency of Braking to Shutdown	0.00 ~ H0.04	Hertz	0.00Hz	✓
H1.07	Waiting Time of Braking to Shutdown	0.0 ~ 50.0s	second	0.0s	✓
H1.08	DC Braking Current to Shutdown	0.0 ~ 150.0	%	0.0	✓
H1.09	DC Braking Time to shutdown	0.0 ~ 50.0s	second	0.0s	✓

Starting Frequency of Braking to Shutdown: In the process of decelerating to shutdown, when reaching the frequency, the converter will implement DC braking to shutdown.

Waiting Time of Braking to Shutdown: Before the DC braking to shutdown, the converter will block the output, and restart after the delay. It is used to prevent the overcurrent caused by DC braking at high speed.

DC braking Current to Shutdown: it refers to the DC current quantity added to the converter. The bigger the current is, the stronger the DC braking will be

DC Braking Time to Shutdown: the time that DC braking goes along. If the time is 0, DC braking is ineffective and the converter will stop according to the set deceleration time.

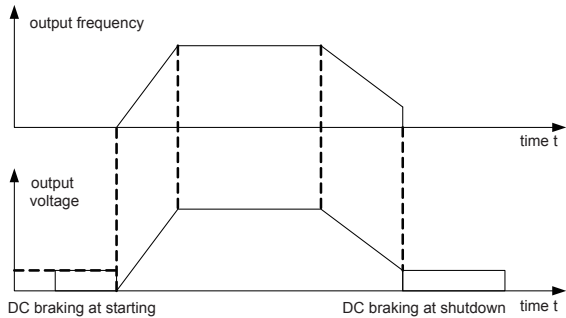

Figure 5-3 DC Braking Diagram

H1.10	Positive Reverse rotation Dead Time	0.0 ~ 3600.0s	second	0.0s	✓
-------	-------------------------------------	---------------	--------	------	---

Shown as below:

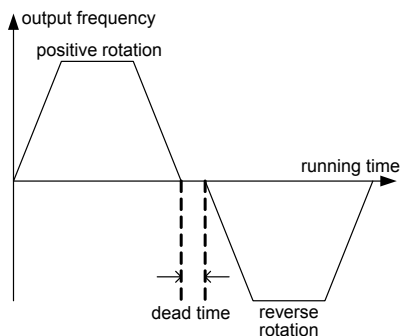

Figure 5-4 Positive Reverse rotation Dead Time Diagram

H1.11	Power On Terminal Running Protection Option	0: invalid terminal running command when power on 1: valid terminal running command when power on	N/A	0	√
-------	---	--	-----	---	---

When the running command channel is terminal control, in the process of converter power on, the system will automatically check the status of running terminal.

0: ineffective terminal running command when power on. Even in the process of power on and the running command terminal is detected to be effective, the converter will not be running. The system will be under the protection status until it removes the running command terminal, and then enable this terminal to make the converter run.

1: effective terminal running command when power on. Even in the process of power on, if the running command terminal is detected to be effective, after completing the initialization, the system will automatically start the converter.

Caution: Users have to select this function with cautions for it may cause serious consequences.

H1.12	Reserved				
-------	----------	--	--	--	--

5.2.3. H2 Motor Parameters Area

H2.00	Type of Converter	0: G Model		0	×
-------	-------------------	-------------------	--	---	---

0: G type, applicable to the constant-torque load that has designated rated parameters.

V. Function Parameter Description P117

H5000 series converter is applicable to constant-torque loads;

The factor parameters setting of the converter is G type,

- ① set the function code as 0;
- ② reset the motor parameters of Group 2.
- ① set the function code as 1;
- ② reset the motor parameters of Group 2

H2.01	Rated Power of Motor	0.4 ~ 900.0kW	kilowatt	Model Setting	×
H2.02	Rated Frequency of Motor	0.01Hz ~ H0.04	Hertz	50.00Hz	×
H2.03	Rated Speed of Motor	0 ~ 36000rpm	rpm	1400	×
H2.04	Rated Voltage of Motor	0 ~ 460V	voltage	380	×
H2.05	Rated Current of Motor	0.1 ~ 2000.0A	ampere	Model Setting	×

Notice: please set the parameters according to the nameplate of motor. The excellent control performance of vector control requires accurate motor parameters.

Converter provides function of parameters self-learning. Accurate parameters self-learning comes from the correct setting of parameters from motor nameplate. In order to ensure the control performance, please set the motor according to the standard adaptation motor of the converter. If the difference between the motor power and the standard adaptation motor is too big, the control performance of the converter will decrease significantly.

Notice: Resetting the motor rated power (H2.01) will initialize the motor parameters from H2.02 to H2.10.

H2.06	Motor Stator Resistance	0.001 ~ 65.535 Ω	ohm	Model Setting	✓
H2.07	Motor Rotor Resistance	0.001 ~ 65.535 Ω	ohm	Model Setting	✓
H2.08	Motor Stator Rotor Inductance	0.1 ~ 6553.5mH	millihenry	Model Setting	✓
H2.09	Motor Stator Rotor Transformer	0.1 ~ 6553.5mH	millihenry	Model Setting	✓
H2.10	No Load Current of Motor	0.01 ~ 655.35A	Ampere	Model Setting	✓

When normally completing the motor parameters self-learning, the setting value of H2.06 to H2.10 will automatically updated. These parameters are the reference parameters of high performance vector control, which can directly affect the

controlling performance.

Caution: Users are not free to modify the parameters in the group.

5.2.4. Group H3, Vector Control Group

H3.00	Speed Circulation Proportional Gain 1	0 ~ 100	N/A	20	√
H3.01	Speed Circulation Integral Time 1	0.01 ~ 10.00s	second	0.50s	√
H3.02	Low Frequency Switching	0.00Hz ~ H3.05	Hertz	5.00Hz	√
H3.03	Speed Circulation Proportional Gain 2	0 ~ 100	N/A	25	√
H3.04	Speed Circulation Integral Time 2	0.01 ~ 10.00s	second	1.00	√
H3.05	High Frequency Switching	H3.02 ~ H0.04	Hertz	10.00Hz	√

The parameters above are only effective to vector control, but ineffective to V/F control. Lower than the switching frequency 1 (H3.02), speed circulation PI parameters are: H3.00 and H3.01. Higher than the switching frequency 2 (H3.05), speed circulation PI parameters are: H3.03 and H3.04. Between the switching points, PI parameter is obtained through two groups of parameter linear changes, shown as follow:

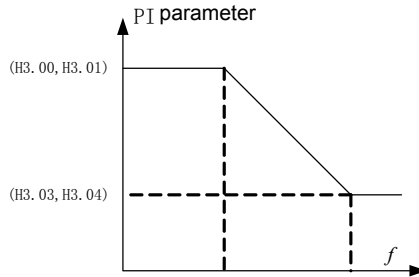

Figure 5-5 Diagram

By setting the proportionality coefficient and integral time of the speed regulator, you can regulate the speed dynamic response characteristics of the vector control. To increase the proportionality gains or reduce the integral time can both accelerate the dynamic response of speed circulation. But over proportional gains or insufficient integral time will easily cause the system oscillation as well as over super-regulation. Insufficient proportional gains will also cause the system

oscillation, and with possible speed static difference.

Speed circulation PI parameters is closely related to the motor system inertia. Users need to regulate on the basis of default PI parameters according to different load characteristics, so as to meet the requirements of various occasions.

H3.06	VC Slip Compensation Coefficient	50% ~ 200%	%	100%	√
-------	----------------------------------	------------	---	------	---

Slip Compensation Coefficient is used to regulate the slip frequency of vector control, improve the speed control accuracy of the system. To appropriately regulate the parameters can effectively suppress the speed static difference.

H3.07	Torque Upper Limit Setting	0.0 ~ 200.0% (converter rated current)	%	150.0%	√
-------	----------------------------	--	---	--------	---

Set 100% of the rated output current corresponding to the converter

5.2.5 Group H4, V/F Control Area

H4.00	V/F Curve Setting	0: straight line V/F curve 1: 2.0 power reduction of torque V/F curve	N/A	0	×
-------	-------------------	--	-----	---	---

The function codes of this group is effective to V/F control (H0.00=1), but ineffective to vector control.

For the load of fans and pumps, square V/F control may be selected.

0: straight V/F curve. Suitable to regular constant-torque loads.

1: 2.0 power V/F curve. Suitable to the centrifugal load of fans and pumps

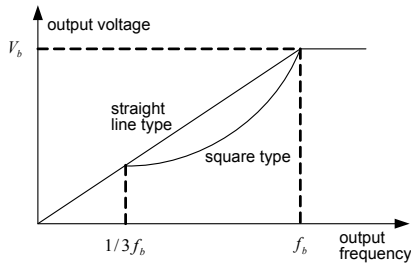

Figure 5-6 V/F Curve Diagram

H4.01	Torque Lifting	0.0%:(automatic) 0.1% ~ 30.0%	%	0.0%	√
H4.02	Torque Lifting Cut-off	0.0% ~ 50.0% (relative rated frequency of motor)	%	20.0%	×

Torque Lifting is mainly applied to the below of cut-off frequency (H4.12). The V/F curve that has been lifted is shown as follow. Torque lifting may improve the

P120 V. Function Parameter Description

characteristics of V/F low frequency torque.

Select the torque quantity according to the load capacity. Increase the lifting if the load is large, but the torque lifting should not be set too much. Over torque lifting causes motor over excitation running. Overheating causes heavy converter output current, and reduces the efficiency. When torque lifting is set to be 0.0%, the converter will be of auto torque lifting.

Cut-off Frequency of Torque Lifting: Under the frequency, torque lifting is effective; over the frequency, torque lifting is ineffective.

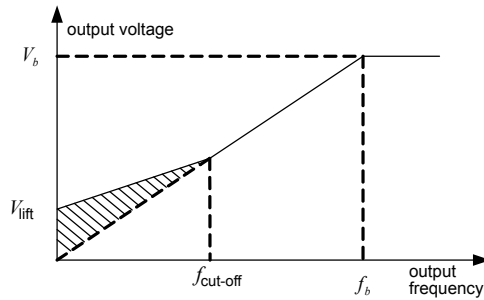

Figure 5-7 Manual Torque Lifting Diagram

H4.03	V/F Slip Compensation Limit	0.0 ~ 200.0%	%	100.0%	√
-------	-----------------------------	--------------	---	--------	---

To set this parameter will compensate the motor speed changes caused by the load in the process of V/F control, and improve the hardness of motor mechanical characteristics. The value should correspond to the motor rated slip frequency.

H4.04	Energy Saving Running Option	0: no action 1: automatic energy saving running	N/A	0	√
H4.05	Reserved				

5.2.6 H5 Input Terminal Area

H5.00	X1 Terminal Function Option	0: no function 1: running in positive rotation 2: running in reverse rotation	N/A	1	×
H5.01	X2 Terminal Function Option	3: three wire running control 4: normal inching turning 5: reverse inching turning 6: free shutdown	N/A	4	×
H5.02	X3 Terminal Function Option	7: fault reset 8: external fault input 9: frequency setting increment (UP)	N/A	7	×
H5.03	X4 Terminal Function Option	10: frequency setting decrement (DOWN) 11: frequency add and delete setting removal 12: multistage speed terminal 1 13: multistage speed terminal 2	N/A	0	×
H5.04	X5 Terminal Function Option	14: multistage terminal 3 15: reserved 16: PID control pause 17: swing frequency pause (at the current frequency)	N/A	0	×
H5.05	X6 Terminal Function Option	18: swing reset (back to center frequency) 19: acceleration and deceleration prohibited 20: torque control prohibited 21: temporary removal of frequency add and delete setting 22~25: reserved	N/A	0	×

0: No Function The converter will not work even if there is signal input. To set the idle terminals as no function may prevent malfunction.

1: Positive Running **2:** Reverse Running To control the positive and reverse rotation of the motor through external terminals.

3: Three Wire Running Control To determine the running mode of the converter to be three wire running control through the terminal. For detail information, refer to H5.07 the introduction to the function code of three wire control mode.

4: positive inching **5:** reverse inching
For the information of frequency, inching acceleration/deceleration time at inching running, refer to H8.02、 H8.03、 H8.04 function code description.

6: Free Shutdown When the converter blocked the output, the stop process of the motor is not controlled by the converter. For big inertia load and with no requirements on the stop time, it is quite a popular method. This method has the same meaning with the free stop description in H1.05.

7: Fault Reset external fault reset function. Same with the function of STOP/RST key on the keyboard. Remote fault reset may be achieved by this function.

8: External Fault Input When the external fault signal is sent to the converter, the

P122 V. Function Parameter Description

converter will report the fault and shutdown.

9: Frequency Setting Increment (UP) **10:** Frequency Setting Decrement (DOWN)

11: Frequency Add and Delete Setting Removal

When the frequency is set by external terminal, modify the frequency increment command, decrement command. When the frequency source setting is digital setting, set frequency can be regulated up and down.

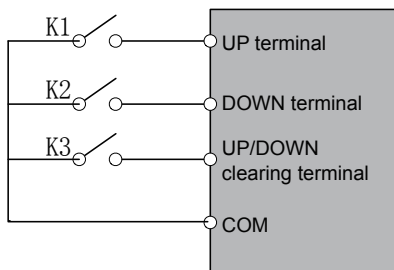

Figure 5-8 Terminal Speed Adjustment Diagram

Terminals can be used to clear UP/DOWN set frequency value, allowing the preset frequency to return to the frequency set by the frequency command channel.

12: multistage terminal 1 **13:** multistage terminal 2 **14:** multistage terminal 3

To achieve the speed setting of the 8 section through the combination of these 3 terminal number status. Notice: multistage 1 is low position. Multistage 3 is high position.

15: Reserved

16: PID Control Pause PID temporarily fails, and the converter will maintain the current frequency output.

17: Swing Frequency Pause (at the current frequency) The converter paused at the current output frequency, and continue swing running after undo the function.

18: Swing Reset (back to central frequency) The converter comes back to the central frequency output.

19: Prohibiting Accelerating and Deceleration To ensure that the converter will not be effected by the external signals (except shutdown command), and maintain the current output frequency.

20: Torque Control Prohibited To prohibit the converter from torque control mode and the converter will switch to the speed control mode.

21: Temporary Removal of Frequency Add and Delete Setting

22~25: Reserved

H5.06	Switching Capacity Filtering Times	1 ~ 10	N/A	5	√
-------	------------------------------------	--------	-----	---	---

V. Function Parameter Description P123

The Wave Filtering Time of Setting X1~X4 Samplings. In the condition of great interference, the parameter should be increased to prevent from error operation.

H5.07	Terminal Control Running Mode	0: two wire control 1 1: two wire control 2 2: three wire control 1 3: three wire control 2	N/A	0	×
-------	-------------------------------	--	-----	---	---

The parameter defines 4 different modes of controlling the running of the converter from external terminals.

0: two-wire control 1. Two-wire control is most popular in this mode. FWD and REV terminal command determines the motor whether in positive rotation or reverse rotation.

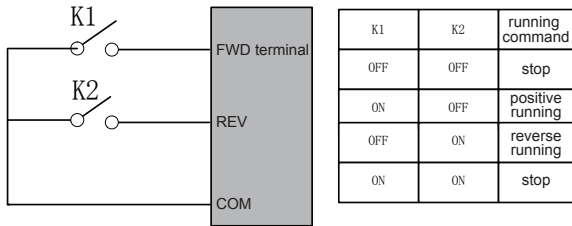

Figure 5-9 Two Wire Running Mode 1 Diagram

1: two-wire control 2. In this mode, FWD is enable terminal. The direction is determined by the status of REV.

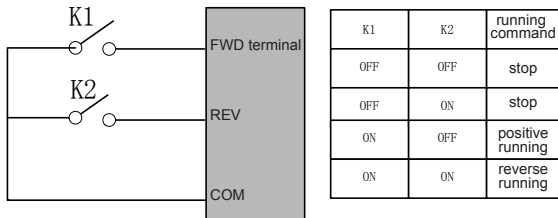

Figure 5-10 Two Wire Running Mode 2 Diagram

2: Three Wire Control 1. In this mode, SIN is enable terminal. The running command is generated by FWD. The direction command is generated by REV. SIN is of normally closed type.

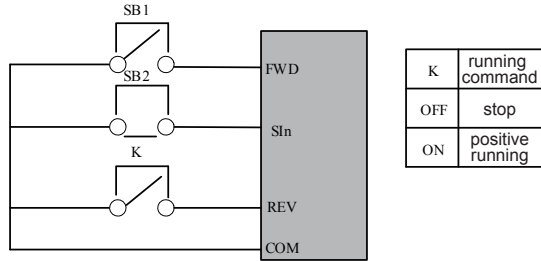

Figure 5-11 Three Wire Running Mode 1 Diagram

Among which: K: positive reverse rotation switch; SB1: running button; SB2: shutdown button

SIn only has to define the corresponding terminal function as No. 3 function “three-wire running function” .

3: three-wire control 2. SIn in this mode is enable terminal. SB 1 or SB 2 gives running command and simultaneously control the direction. The normally-closed SB 2 gives shutdown command.

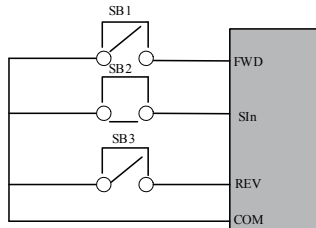

Figure 5-12 Three Wire Running Mode 2 Diagram

Among which ; SB1: positive reverse rotation running button; SB2: shutdown button; SB3: reverse running button

SIn works as three wire running control which defines the corresponding terminal as No. 3 function.

NOTE: For the two-wire operating mode, when FWD/REV terminal effective, the converter will be shutdown by the shutdown command from other source. Even the control terminal FWD/REV is still effective, the converter will not be running after the shutdown command disappears. If the converter needs to be running, trigger FWD/REV again.

V. Function Parameter Description P125

H5.08	Incremental Change Rate of Terminal Rising and Descending Frequency	0.01 ~ 50.00Hz/s	Hertz/s	0.50Hz/s	✓
-------	---	------------------	---------	----------	---

The port ascension is descended frequency to adjust enactment frequency of variety rate.

H5.09	VIN Lower Limit	0.00V ~ 10.00V	Voltage	0.00V	✓
H5.10	Setting Corresponding to VIN Lower Limit	-100.0% ~ 100.0%	%	0.0%	✓
H5.11	VIN Upper Limit	0.00V ~ 10.00V	Voltage		✓
H5.12	Setting Corresponding to VIN Upper Limit	-100.0% ~ 100.0%	%	100.0%	✓
H5.13	VIN Input Wave Filtering Time	0.00s ~ 10.00s	second	0.10s	✓

The function codes above defined the relationship between the analogy input voltage and the set value corresponding to the analogy input. When the analogy input voltage goes beyond the set range of maximum input or minimum input, the external part will be calculated as the maximum input or the minimum input.

When the current input is analogy input, 0mA ~ 20mA corresponds to 0V ~ 10V
In different application occasion, 100% of analogy setting corresponds to different nominal values. Refer to the specific description of application parts.

The following figure illustrated several setting cases: Pay Attention: The VIN lower limit value must be smaller or equal to the VIN upper limit value.

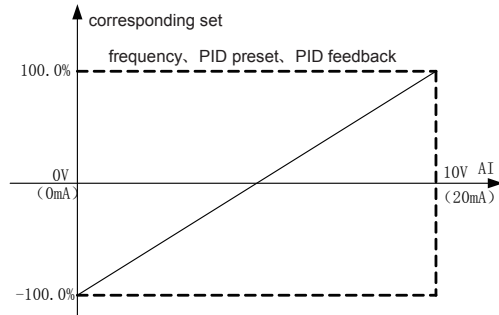

Figure 5-13 Corresponding Relationship Between Analogy Preset and Set Quantity

VIN Input Wave Filtering Time: it determines the sensibility of the analogy input. In order to prevent the analogy from interferences that may cause malfunction, increase the parameter as the anti-interference ability will be increased accordingly, but that will reduce the sensibility of the analogy input.

P126 V. Function Parameter Description

H5.14	SIN Lower Limit	0.00V ~ 10.00V	Voltage	0.00V	✓
H5.15	Setting Corresponding to SIN Lower Limit	-100.0% ~ 100.0%	%	0.0%	✓
H5.16	SIN Upper Limit	0.00V ~ 10.00V	Voltage	10.00V	✓
H5.17	Settings Corresponding to SIN Upper Limit	-100.0% ~ 100.0% 100.0%	%	100.0%	✓
H5.18	SIN Input Wave Filtering Time	0.00s ~ 10.00s	second	0.10s	✓

The setting method of SIN function is similar with that of VIN. Analogy SIN can support 0 ~ 10V or 0 ~ 20mA input. When SIN selects 0 ~ 20mA input, the voltage corresponding to 20mA input is 10.

5.2.7. H6 Output Terminal Area

H6.00	Y1	0: no output 1: motor in running 2: motor in reverse rotation 3: fault output 4: frequency level detection FDT output 5: frequency reaching 6: running in zero speed 7: reaching the upper limit of frequency 8: reaching the lower limit of frequency 9~10: reserved	N/A	1	✓
H6.01	Y2		N/A	0	✓
H6.02	Y3		N/A	0	✓
H6.03	Relay Output Option		N/A	3	✓

0: No Output output terminal has no function

1: Motor in Running Indicating that the converter is in running and has output frequency. ON signal is output at this time.

2: Motor in reverse rotation indicating that the converter is in reverse running and has output frequency. ON signal is output at this time.

3: Fault Output ON signal is output when the converter is inoperative.

4: Frequency Level Detection FDT Output See functional code H8.11, H8.12 in details.

5: Frequency Reaching See functional code H8.13 in details.

6: Running in Zero Speed ON signal is output when the converter output frequency is smaller than starting frequency.

7: Reaching the Upper Limit of Frequency ON signal is output when the running frequency reaches the upper limit.

8: Reaching the Lower Limit of Frequency ON signal is output when the running frequency reaches the lower limit.

V. Function Parameter Description P127

H6.04	FM (AM) Output Option	0: running frequency 1: set frequency 2: running speed 3: output current 4: output voltage 5: output power 6: output torque 7: analogy VIN input value 8: analogy SIN input value 9~10: reserved	N/A	0	√
-------	-----------------------	---	-----	---	---

*FM (AM) the both two shared one route of output.

The standard output of analogy output is 0 ~ 20mA (or 0 ~ 10V) . The current output or voltage output can be selected by the jumper. The corresponding quantity is as follows:

- 0:** running frequency 0~maximum output frequency
- 1:** set frequency 0~maximum output frequency
- 2:** running speed 0~2 times of motor rated speed
- 3:** output current 0~2 times of converter rated current
- 4:** output voltage 0~1.5 times of converter rated voltage
- 5:** output power 0~2 times rated power
- 6:** output torque 0~2 times of motor rated current
- 7:** analogy VIN input value 0~20V
- 8:** analogy SIN input value 0~10V/0~20mA

H6.05	FM (AM) Output Lower Limit	0.0% ~ 100.0%	0.0%	0.0%	√
H6.6	FM (AM) Output Corresponding to Lower Limit	0.00V ~ 10.00V	0.00V	0.00V	√
H6.07	FM (AM) Output Upper Limit	0.0% ~ 100.0%	100.0%	100.0%	√
H6.08	FM (AM) Output Corresponding to Upper Limit	0.00V ~ 10.00V	10.00V	10.00V	√

The function codes above defined the relationship between the output value and the analogy output value. When the output value goes beyond the set range of the maximum output or the minimum output, the external part will be calculated as the maximum output or the minimum output.

When the current output is analogy output, 1mA current equals to 0.5V.

In different application occasions, 100% of the output value corresponds to different analogy output quantity. Refer to specific descriptions of application parts.

The following figure illustrates several setting cases

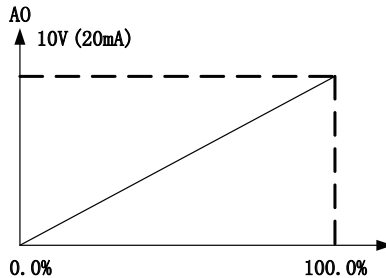

Figure 5-14 Corresponding Relationship Between Preset and Analogy Output

5.2.8 Group H7, Man-Machine Interface

H7.00	User Password	0 ~ 65535	N/A	0	√
-------	---------------	-----------	-----	---	---

Set any number except zero, and the password protection function become effective.

00000: eliminate the password of former user, and the password protection function become invalid. Return the factory value also will eliminate the password. When user password has been set and taken into effect, if user password is not correct, the user will not be able to enter the parameter menu. Only by inputing the correct password, the user can check for the parameters or modify the parameters. Please serious! remember the user password you' ve set.

Exiting the function code editing, password protection will be effective in 1 minuter later. When the password took into effect, if push PRG key to enter the function code editing, "00000" will be displayed. The operator must correctly input the user password, otherwise will not be able to enter.

H7.03	Function Option of QUICK/JOG Key	0: inching running 1: positive reverse rotation switching 2: clear UP/DOWN setting	N/A	0	x
-------	----------------------------------	---	-----	---	---

QUICK/JOG key, i.e. multi function key. The function of keyboard QUICK/JOG key can be defined by parameter setting.

0: Inching Runing. Keyboard QUICK/JOG key is used to realize the inching running.

1: Positive Reverse rotation Switching. Keyboard QUICK/JOG key is used to realize the switching of frequency command direction. Only effective in keyboard command channel.

2: Clear UP/DOWN Setting. Keyboard QUICK/JOG key is used to clear the UP/DOWN setting value.

V. Function Parameter Description P129

H7.04	Shutdown Function Option of STOP/RST Key	0: only effective to running panel control 1: effective to both running panel and terminal control 2: effective to panel and communication control 3: effective to all control modes	N/A	0	√
-------	--	---	-----	---	---

This functional code defines effective option of STOP/RST shutdown function. For fault reset, STOP/RST key is effective under any circumstances.

H7.05	Keyboard Display Option	0: external keyboard priority 1: display both local and external keyboard; only the external keys are effective. 2: display both local and external keyboard; only the local keys are effective.	N/A	0S	√
-------	-------------------------	---	-----	----	---

This function sets the logic relationship of keys display between the local keyboard and external keyboard.

Caution: Function 3 should be used with caution. Error action may cause serious consequences.

H7.06	Parameter Option Displayed in Running	0 ~ 0x7FFF FE: running frequency Fd: set frequency FC: bus voltage Fb: output voltage FA: output current F9: running speed F8: output power F7: output torque F6: PID preset value F5: PID feedback value F4: input terminal status F3: output terminal status F2: analogy VIN value F1: analogy SIN value F0: current section of multistage speed	N/A	0xFF	√
-------	---------------------------------------	---	-----	------	---

When the converter is in the running status, the function code is effective to the parameter display, i.e. a 16-bit binary number. If any bit is 1, the parameter corresponding to the bit can be checked through transpose at running. If the bit is 0, the parameter corresponding to the bit cannot be displayed. When setting function code H7.06, binary numbers should be switched to hexadecimal numbers to input the function code.

P130 V. Function Parameter Description

The lower 8 bits BIT 7~ BIT 0 and the upper 8 bits BIT 15~BIT 8 display the same contents as those in the table above.

H7.07	Parameter Option Displayed when Shutdown	1 ~ 0x1FF FE: set frequency Fd: bus voltage FC: input terminal status Fb: output terminal status FA: PID preset value F9: PID feedback value F8: analogy VS1 value F7: analogy variable SIN value F6: current section of multistage speed F5~F0: reserved	无	0xFF	√
-------	--	---	---	------	---

The function has the same setting with P6-06. When the converter is shutdown, the function code is effective to the parameter display. The lower 8 bits BIT 7~ BIT 0 and the upper 8 bits BIT 15~BIT 8 display the same contents as those in the table above.

H7.08	Rectifier Module Temperature	0 ~ 100.0°C	centigrade		
H7.09	Inverter Module Temperature	0 ~ 100.0°C	centigrade		
H7.10	Software Version		N/A	3.00	
H7.11	Local Accumulative Running Time	0 ~ 65535h	hour	0	

These functional codes are used for check only, no modification.

Rectifier Module Temperature, indicates the temperature of the rectifier module. Rectifier module of different models may have different over temperature protection value.

Inverter Module Temperature, indicates the IGBT temperature of inverter module. Inverter module of different models may have different IGBT over temperature

V. Function Parameter Description P131

H7.12	Types of the Former 2 Faults	0: no fault 1: inverter unit U phase protection (E001) 2: inverter unit V phase protection (E002) 3: inverter unit W phase protection (E003) 4: accelerat overcurrent (E004) 5: decelerat overcurrent (E005) 6: constant overcurrent (E006) 7: accelerate overvoltage (E007) 8: decelerate overvoltage (E008) 9: constant overvoltage (E009) 10: bus undervoltage fault (E0010) 11: motor overload (E0011) 12: converter overload (E0012) 13: input lateral lack of phase (E0013) 14: output lateral lack of phase (E0014) 15: rectifier module overheating (E0015) 16: inverter module overheating fault (E0016) 17: external fault (E0017) 18: communication fault (E0018) 19: current detection fault (E0019) 20: motor self-learning fault (E0020) 21: EEPROM running fault (E0021) 22: PID feedback disconnected fault (E0022) 23: braking unit fault (E0023) 24: reserved	N/A		
H7.13	Type of the Last Fault	17: external fault (E0017) 18: communication fault (E0018) 19: current detection fault (E0019) 20: motor self-learning fault (E0020) 21: EEPROM running fault (E0021) 22: PID feedback disconnected fault (E0022) 23: braking unit fault (E0023) 24: reserved	N/A		
H7.14	Type of the Existing Fault	17: external fault (E0017) 18: communication fault (E0018) 19: current detection fault (E0019) 20: motor self-learning fault (E0020) 21: EEPROM running fault (E0021) 22: PID feedback disconnected fault (E0022) 23: braking unit fault (E0023) 24: reserved	N/A		

Record the type of recent 10 faults of the converter: 0 means no fault, 1~24 means 24 various types of faults (see the table above for specific functions).

H7.15	Existing Fault Running		Hertz		
H7.16	Existing Fault Output Current		Ampere	0.0A	
H7.17	Existing Fault Bus Voltage		Voltage	0.0V	
H7.18	Existing Fault Input Terminal Status		N/A	0	
H7.19	Existing Fault Output Terminal Status		N/A	0	

Existing Fault Operating Frequency: the output frequency at the existing fault.

Existing Fault Output Current: the output current at the existing fault.

Existing Fault Bus Voltage: the bus voltage at the existing fault.

5.2.9 Group H8, Enhanced Parameter Area

H8.00	Acceleration Time	0.1 ~ 3600.0s	second	20.00s	√
H8.01	Deceleration Time	0.1 ~ 3600.0s	second	20.00s	√
H8.02	Inching Running Frequency	0.00 ~ H0.04	Hertz	5.00Hz	0.00 ~ H0.04
H8.03	Inching Running Acceleration Time	0.1 ~ 3600.0s	second	20.00s	√
H8.04	Inching Running Deceleration Time	0.1 ~ 3600.0s	second	20.00s	√

Define the preset frequency and acceleration time of the converter in inching running. Start or stop the inching running process in direct starting mode or decelerating stop mode.

Inching running acceleration time, refers to the time that the converter will take accelerating from 0Hz to the maximum output frequency (H0.04).

Inching running deceleration time, refers to the time that the converter will take decelerating from the maximum output frequency (H0.04) to 0Hz.

H8.05	Jump Frequency	0.00 ~ H0.04	Hertz	0.00Hz	√
H8.06	Jump Frequency Amplitude	0.00 ~ H0.04	Hertz	0.00Hz	√

When the set frequency is within the range of jump frequency, the actual operating frequency will be at the jump frequency boundary, a much smaller distance from the set frequency.

The converter will avoid load mechanical resonance by setting jump frequency. The converter can set one jump frequency point. The function will be inoperative when all jump frequencies are set to 0.

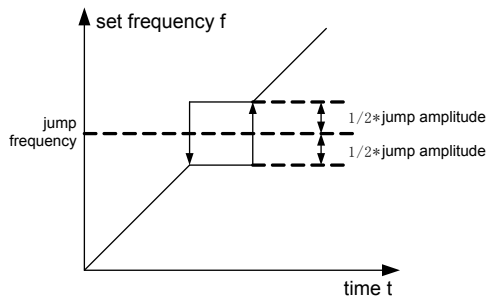

Figure 5-15 Jump Frequency Diagram

H8.07	Swing Amplitude	0.0 ~ 100.0% (relative set frequency)	%	0.0%	√
H8.08	Jump Amplitude	0.0 ~ 50.0% (relative swing frequency amplitude)	%	0.0%	√
H8.09	Rising Time of Swing Frequency	0.1 ~ 3600.0s	second	5.0s	√
H8.10	Descent Time of Swing Frequency	0.1 ~ 3600.0s	second	5.0s	√

Swing frequency function can be applied to textile, chemical fiber industry and occasions that require traverse and winding function.

Swing frequency function refers to the converter output frequency to swing up and down, taking the set frequency as the center. The track of the running frequency on the time scroll is shown as follows, among which, H8.07 set the swing amplitude. When H8.07 set zero, i.e. swing amplitude is zero, swing amplitude will be ineffective.

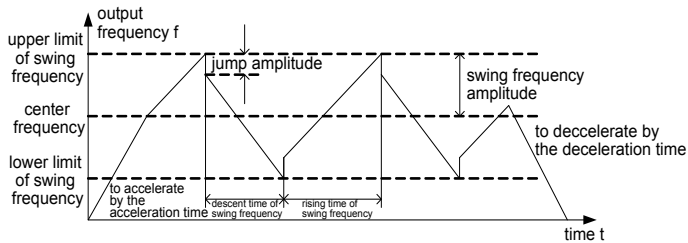

Figure 5-16 Swing Frequency Running Diagram

Swing Frequency Amplitude: the running frequency of the swing frequency is limited by the upper and lower limit frequency.

Swing Amplitude Relative to the Center Frequency: $\text{Swing Amplitude AW} = \text{Center Frequency} \times \text{Swing Amplitude H8.07}$.

Jump Frequency = $\text{Swing Amplitude AW} \times \text{Jump Frequency Amplitude H80.8}$. i.e. the relative swing amplitude value of jump frequency when swing frequency is running.

Swing Frequency Rising Time: the time for swing frequency running from the lowest point to the highest point.

Swing Frequency Descending Time: the time for swing frequency running from the highest point to the lowest point

P134 V. Function Parameter Description

H8.11	Automatic Fault Reset Times	0 ~ 3	N/A	0	
H8.12	Interval Time Setting of Automatic Fault Reset	0.1 ~ 100.0s	second	1.0s	

Automatic Fault Reset Times: when the converter selects the automatic fault reset, it is used to set the times of the automatic reset. Beyond that value, the converter will shutdown at fault and wait for repair.

Interval Time Setting of Automatic Fault Reset: select the time interval between the fault occurrence and automatic reset action.

H8.13	FDT Level Detection Value	0.00 ~ H0.04	Hertz	50.00Hz	√
H8.14	FDT Lag Detection Value	0.0 ~ 100.0% (FDT level)	%	5.0%	√

Set the detection value of output frequency and the lag value of relieving output action. Shown as below:

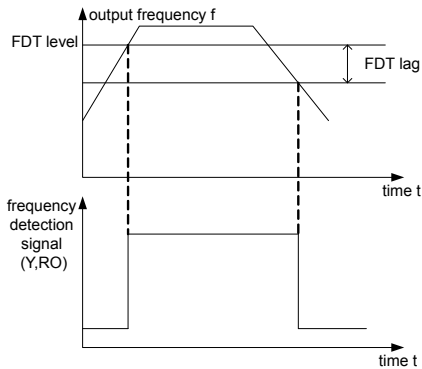

Figure 5-17 FDT Level Diagram

H8.15	Frequency Reaching Detection Amplitude	0.0 ~ 100.0% (maximum frequency)			
-------	--	----------------------------------	--	--	--

When the output frequency of converter reaches the frequency preset value, the function can adjust the detection amplitude value. Shown as below:

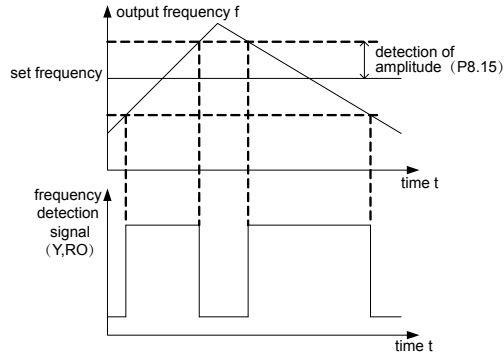

Figure 5-18 Diagram of Frequency Reaching Detection of Amplitude

H8.16	Brake Valve Voltage	115.0 ~ 140.0% (standard bus voltage)	%	125.0%	✓
-------	---------------------	--	---	--------	---

The functional code is the initial bus voltage of setting dynamic braking. To appropriately adjust the value will effectively brake the load.

H8.17	Speed Display Coefficient	0.1 ~ 999.9% Mechanical speed=120*runningal frequency*H8.17/motor pole pairs	%	100.0%	✓
-------	---------------------------	---	---	--------	---

Mechanical speed=120*runningal frequency*H8.17/motor pole pairs. The functional code is used for aligning display errors of speed scale, having no effect to the actual speed.

5.2.10 Group H9, PID Parameter Area

PID control is a common method for process control. It regulates the output frequency of the converter through proportional, integral and differential computing of deviation quantity between the feedback signals and targeting signals of controlled quantity, so that to construct a feedback system, stabilizing the controlled quantity to be at the targeting quantity. It is applicable to the process control such as flow control, pressure control and temperature control. The basic principle of PID control is shown as follows:

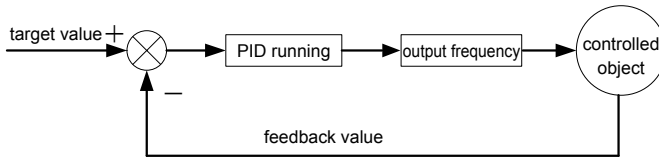

Figure 5-23 Principle Diagram of Process PID

H9.00	PID Preset Source Option	0: keyboard preset 1: analogy channel VIN preset 2: analogy channel SIN preset 3: remote communication preset 4: multistage preset	N/A	0	√
-------	--------------------------	---	-----	---	---

When frequency source selects PID, i.e. H0.03 selecting 5, the functions will take effect. The parameter determines the process PID target quantity to preset the channel.

The set target of process PID is a relative value. 100% setting corresponds to 100% feedback signal of controlled system; the system will operate according to the relative value (0~100.0%) all the time.

H9.01	Keyboard PID Preset	0.0% ~ 100.0%	%	0.0%	×
-------	---------------------	---------------	---	------	---

When select H9.00=0, i.e. target source being keyboard preset. The parameter is required to be set.

H9.02	PID Feedback Source Option	0: analogy channel VIN feedback 1: analogy channel SIN feedback 2: VIN+SIN feedback 3: remote communication feedback	N/A	0	√
-------	----------------------------	---	-----	---	---

Select PID feedback channel through the parameter.

Notice: Preset channel can not overlap the feedback channel, otherwise, PID cannot be effectively controlled.

H9.03	PID Output Characteristic Option	0: PID output of positive characteristic 1: PID output of negative characteristic	N/A	0	1
-------	----------------------------------	--	-----	---	---

PID Output of Positive Character: when feedback signal is bigger than PID preset, decreasing the output frequency of the converter can get PID back to balance, such as winding tension PID control.

PID Output of Negative Characteristic: when feedback signal is bigger than PID preset, increasing the output frequency will get the PID back to balance, such as unwinding tension PID control.

H9.04	Proportional Gain (Kp)	0.00 ~ 100.00	N/A	1.00	√
H9.05	Integral Time (Ti)	0.00 ~ 10.00s	second	0.10s	√
H9.06	Differential Time (Td)	0.00 ~ 10.00s	second	0.00s	√

Proportional Gains (Kp): it determines the regulating strength of the entire PID regulator. The bigger the P is, the bigger the regulating strength will be. When the parameter is 100, it means that when the deviation between the PID feedback quantity and the preset quantity is 100%, the regulation of the output frequency command from PID regulator will reach the maximum frequency (ignoring integral effects and differential effects).

Integral Time (Ti): it determines the speed of PID regulator integrally regulating the deviation between the PID feedback quantity and the preset quantity. Integral time refers to that if the deviation between the PID feedback quantity and the preset is 100%, the regulation of the integral regulator (ignoring proportional effects and differential effects) after continuous regulating period, will reach the maximum frequency (H0.04). The shorter the integral time is, the bigger the regulating strength will be.

Differential Time (Td): it determines the strength of PID regulator regulating the rate of change of the PID feedback quantity and the preset quantity. Differential time refers to that if the feedback quantity changed 100% within the time, the regulation of the differential regulator will reach the maximum frequency (H0.04) (ignoring proportional effects and integral effects). The longer the differential time is, the stronger the regulator will be.

PID is most common method in the process control. Each part has different functions. The following is a brief introduction to the working principle and regulation method:

Proportional Time (P): When the feedback deviated from the preset, output the proportional regulation according to the deviation. If the deviation is constant, the regulation should also be constant. Proportional regulation can rapidly response to the feedback changes, but simply using proportional regulation can not control without errors. The bigger the proportional gain, the faster the system regulating speed. But too much regulation will cause oscillation. The regulation method is as follows: first to set the integral time very long, differential time is set to be zero. To the run the system by proportional regulation alone, change the preset quantity, observe the (static) deviation between the feedback signals and the stable preset. If the static deviation is in the direction of the preset changes (for example, increase the preset, and then the feedback quantity is always smaller than the preset after the system stalized), continue to increase the proportional gains, on the contrary, decrease the proportional gains. Repeat the process above, till the static difference is small (hard to make no static difference).

Integral Time (I): when the feedback deviated from the preset quantity, output regulation has been continuously accumulated. If the deviation continues, the regulation will increase until there is no deviation any more. Integral regulator

can effectively eliminate static differences. If the integral regulator is too strong, there will be repeated super-regulating, which makes the system unstable till oscillation occurs. The oscillation caused by the integral function too strong has features as follows: the feedback signals swing up and down around the preset, the swing amplitude progressively increases till oscillation occurs. The integral time parameters usually are regulated from big to small. Progressively regulate the integral time, observe the effect of system regulating until the stability of the system meets the requirement.

Differential Time (D) : When the feedback changed from the preset divation, output the proportional regulation of the deviation change rate. The regulation is only related to the direction and size of the deviation change, not related to the direction and size of the deviation itself. The function of differential regulation is to regulate according to the changing trend when the feedback signals have changed, so as to suppress the change of feedback signals. Differential regulator should be used with caution, because it is easy for the regulator to enlarge the system interferences, especially those of higher rate of change.

H9.07	Sampling Period	0.01 ~ 100.00s	second	0.10s	✓
H9.08	PID Control Deviation Limit	0.0 ~ 100.0%	%	0.0%	✓

Sampling Period (T), refers to the sampling period of feedback quantity. The regulator will calculate once in each sampling period. The longer the sampling period, the slower the feedback will be.

PID Control Deviation Limit, refers to the allowable maximum deviation of PID system output value relative to specified value of closed loop. As shown in the diagram, within the deviation limit, PID regulator stop regulating. To appropriate set the functional code will adjust the precision and stability of PID system.

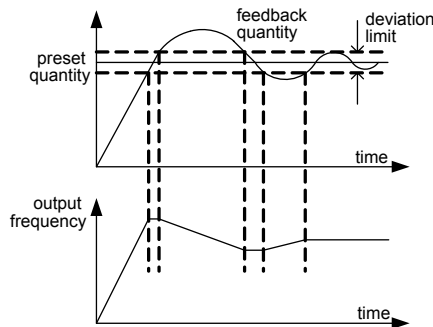

Figure 5-24 Corresponding Relationship Between Deviation Limit and Output Frequency

H9.09	Feedback Disconnected Detection Value	0.0 ~ 100.0%	%	0.0%	√
H9.10	Feedback Disconnected Detection Time	0.0 ~ 3600.0s	second	1.0s	√

Feedback Disconnected Detection Value, corresponds to full scale (100%). The system continuously detects the feedback quantity. When the feedback value is smaller or equal to the feedback disconnected detection value, the system will start to count time. When the detection time is over the feedback disconnected detection time, the system will report PID feedback disconnected Error (PIDE).

5.2.11 Group HA, Multistage Speed Parameters Area

	Multistage Speed 0	-100.0 ~ 100.0%	%	0.0%	√
HA.01	Multistage Speed 1	-100.0 ~ 100.0%	%	0.0%	√
HA.02	Multistage Speed 2	-100.0 ~ 100.0%	%	0.0%	√
HA.03	Multistage Speed 3	-100.0 ~ 100.0%	%	0.0%	√
HA.04	Multistage Speed 4	-100.0 ~ 100.0%	%	0.0%	√
HA.05	Multistage Speed 5	-100.0 ~ 100.0%	%	0.0%	√
HA.06	Multistage Speed 6	-100.0 ~ 100.0%	%	0.0%	√
HA.07	Multistage Speed 7	-100.0 ~ 100.0%	%	0.0%	√

Instruction: The multistage speed symbol determines the running direction. If it is negative value, then the running would be in the opposite direction. The frequency setting 100.0% corresponds to the maximum frequency (H0.04).

If X1=X2=X3=OFF, the frequency input mode is determined by code H0.03. If not all X1, X2, X3 terminals are off, start multistage speed running. Multistage speed has higher priority than keyboard, analog, communication frequency input. Through combined coding of X1, X2 and X3, 8 speed sections can be selected at most.

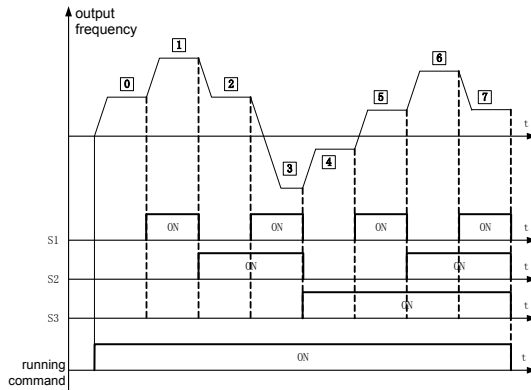

Figure 5-19 Logic Diagram of Multistage Speed

The start and stop channel for multistage speed running also is determined by functional code H0.01. The control process of multistage speed is shown in figure 5-19. The relationship between multistage speed section and X1, X2, X3 terminals is shown as follows:

Relationship Between Multistage Speed Section and X1, X2, X3 Terminal.

X1	OFF	ON	OFF	ON	OFF	ON	OFF	ON
X2	OFF	OFF	ON	ON	OFF	OFF	ON	ON
X3	OFF	OFF	OFF	OFF	ON	ON	ON	ON
Running Section	0	1	2	3	4	5	6	7

5.2.12 Group Hb, Protection and Fault Parameters Area

Hb.00	Motor Overload Protection Options	0: Not Protect 1: Ordinary Motor (with low speed compensation) 2: Variable Frequency Motor (without low speed compensation)	N/A	1	x
-------	-----------------------------------	--	-----	---	---

0: Not protect. Without motor overload protection property (cautiously used), at this moment, there is no overload protection to load motor from converter.

1: Ordinary motor (with low speed compensation). Owing to the bad heat dissipation effect of ordinary motor under low speed condition, corresponding electron heat protection value would also be adjusted properly, the low speed compensation property here means the overload protection valve value of motor whose operation frequency is lower than 30HZ should be down regulated.

V. Function Parameter Description P141

2: Variable frequency motor (without low speed compensation). Since heat dissipation of variable frequency special motor would not be affected by rotate speed, protective value during operation at low speed is not necessary to be adjusted.

Hb.01	Overload Protection Current of Motor	20.0% ~ 120.0% (Rated Current of Motor)	%	100.0%	√
-------	--------------------------------------	---	---	--------	---

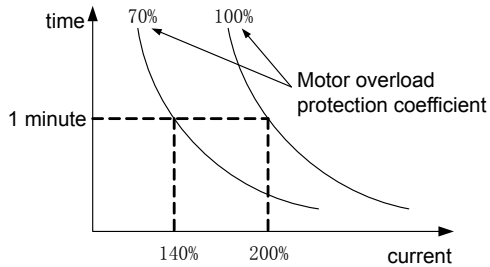

Figure 5-20 Motor Overload Protection Coefficient Setting

This value could be determined by following formula:

Overload Protection Current of Motor = (Allowable Maximum Load Current/Rated Current of Converter) * 100%.

Generally allowable maximum load current is defined as the rated current of load motor. When the rated current value of load motor is not matched with rated current of converter, overload protection of motor could be achieved through setting value of Hb.00 ~ Hb.01.

Hb.02	Under-clocking Point of Instant Power-Down	70.0 ~ 110.0% (Standard Bus Voltage)	%	80.0%	√
Hb.03	Descending Rate of Instant Power-Down Frequency	0.00Hz ~ H0.04	Hz	0.00Hz	√

When the descent rate of instant power-down frequency is set as 0, restart function of instant power-down is invalid.

Under-clocking point of instant power down: After power grid is down, when bus voltage has descended to instant power down under-clocking point, converter would start to descend operation power down according to instant power down descent rate (Hb.03), which makes the motor is in generating status and allow feedback electrical energy to keep bus voltage, guaranteeing normal operation of converter until converter could be power-on again.

Notice: Proper adjustment of these two parameters could commendably achieve power grid switching, and could not lead to production shutdown that is caused

by converter protection.

Hb.04	Overvoltage Stall Protection	0: Prohibition 1: Permission	N/A	0	✓
Hb.05	Overvoltage Stall Protection Voltage	110 ~ 150% (380V Series)	%	120%	✓

During deceleration operation of converter, due to influence of load inertia, actual descent rate of motor rotate speed might be lower than descent rate of output frequency. At this time, electrode would feedback electrical energy to converter, which could cause bus voltage of converter ascend, and then bring about frequency convertor trip that led by bus overvoltage failure, if no measures are adopted.

Overvoltage stall protection function could detect bus voltage during operation of converter, and compare with stall overvoltage point that defined at Hb.05 (relative to standard bus voltage). Output frequency of converter would stop descending if stall overvoltage point has been exceeded, and keep on deceleratedly operating after bus voltage is detected still lower than overvoltage stall point again.

As shown in the figure:

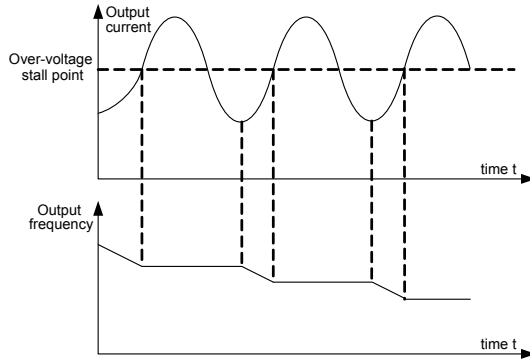

Figure 5-21 Overvoltage Stall Function

Hb.06	Automatic Current-Limiting Level	100 ~ 200%	%	200%	✓
Hb.07	Frequency Descent Rate During Current-Limiting	0.00 ~ 100.00Hz/s	Hz/Second	00.00Hz/s	✓

Owing to heavy load, actual ascent rate of motor rotate speed is lower than ascent rate of output frequency during operation, if no measure is taken, it would cause accelerating over-current failure and lead to converter trip.

Over-current stall protection function could detect output current during operation of converter, and compare with current-limiting level point that defined at Hb.06. output frequency of converter would decrease per descent rate (Hb.07) of over-current frequency if current-limiting level point has been exceeded, and would recover to normal operation after output current is detected still lower than current-limiting level point. See figure:

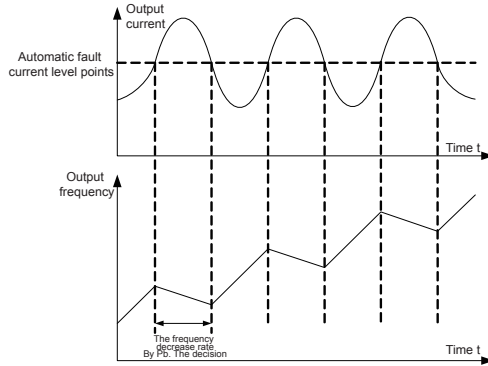

Figure 5-22 Diagram of Current-Limiting Protection Function

5.2.13 Group Hc, 485 Parameters Area

Hc.00	Local Communication Address	1 ~ 247, 0 is Broadcast Address	No	1	√
-------	-----------------------------	---------------------------------	----	---	---

When host machine is writing frame, it would be broadcast address since communication address of slave machine is set as 0, all slave machines on MODBUS bus would accept this frame, but slave machine would not answer. Notice: Address of slave machine could not be set as 0.

Local communication address is provided with uniqueness in communication network, which is the foundation of realizing point-to-point communication between upper computer and converter.

Hc.01	Setting of Communication Baud Rate	0: 1200BPS 1: 2400BPS 2: 4800BPS 3: 9600BPS 4: 19200BPS 5: 38400BPS	No	3	√
-------	------------------------------------	--	----	---	---

This parameter is applied to set up data transmission rate between upper computer and converter. Notice: Baud rate of upper computer and converter must

P144 V. Function Parameter Description

be set with no difference; otherwise, communication could not be carried out. The bigger the Baud rate is, the faster the communication speed would be.

Hc.02	Data Bits Parity Setting	0: No Parity (N, 8, 1) for RTU 1: Even Parity (E, 8, 1) for RTU 2: Odd Parity (O, 8, 1) for RTU 3: No Check (N, 8, 2) for RTU 4: Even Parity (E, 8, 2) for RTU 5: Odd Parity (O, 8, 2) for RTU 6: No Parity (N, 7, 1) for ASCII 7: Even Parity (E, 7, 1) for ASCII 8: Odd Parity (O, 7, 1) for ASCII 9: No Parity (N, 7, 2) for ASCII 10: Even Parity (E, 7, 2) for ASCII 11: Odd Parity Check (O, 7, 2) for ASCII 12: No Parity (N, 8, 1) for ASCII 13: Even Parity (E, 8, 1) for ASCII 14: Odd Parity (O, 8, 1) for ASCII 15: No Parity (N, 8, 2) for ASCII 16: Even Parity (E, 8, 2) for ASCII 17: Odd Parity (O, 8, 2) for ASCII	No	0	√
-------	--------------------------------	---	----	---	---

The data form set on upper computer and converter must be with no difference, otherwise, communication could not be carried out.

Hc.03	Communication Response Time-Delay	0 ~ 200ms	Millisecond	5ms	√
-------	--------------------------------------	-----------	-------------	-----	---

Response Time-delay: it refers to middle time interval between data has been accepted by converters and response data has been sent by upper computer. If response time-delay is shorter than system processing time, then response time-delay would be subject to system processing time, and if response time-delay is longer than system processing time, then system needs to wait after data has been processed by system until response time-delay has been reached and then data would be sent to upper computer.

Hc.04	Communication Overtime Failure Time	0.0 (Invalid) , 0.1 ~ 100.0s	Second	0.0s	√
-------	--	---------------------------------	--------	------	---

When this function code is set as 0.0s, time parameter of communication overtime is invalid. When this function code is set as effective value, system would report communication failure error (CE) if interval time between one communication and the next communication has exceeded communication overtime time.

As usually, all of them would be set as invalid. If sub-parameter is set in continuous communication system, communication status could be monitored.

V. Function Parameter Description P145

Hc.05	Transmission Error Processing	0: Alarm and stop freely. 1: Do not alarm and keep on operating. 2: Do not alarm, and stop per shutdown method (only under communication control method). 3: Do not alarm, and stop per shutdown method (under all control methods).	No	1	√
-------	-------------------------------	---	----	---	---

Converter could keep on operating through setting protection action option to shield failure alarm and shutdown in communication abnormal condition.

Hc.06	Transmission Response Processing	0: Write down operation with response. 1: Write down operation without response.	No	0	√
-------	----------------------------------	---	----	---	---

When this function code is set as 0, converter would response to all read–write command of upper computer. When this function code is set as 1, converter would only response to read command, and have no response to write command. Communication efficiency could be increased through this method.

5.2.14 Group Hd, Additional Parameters Area

Hd.00	Oscillation Suppression Low Frequency Threshold Point	0 ~ 500	N/A	5	√
Hd.01	Oscillation Suppression High Frequency Threshold Point	0 ~ 500	N/A	100	√

But current oscillation is easy to appear when operating in certain frequency segment of most motors, then motor could not operate stably or even cause converter over–current. When Hd.04=0, oscillation could be suppressed, when Hd.00 and Hd.01 are set as small, oscillation suppression effect would be evident and current would be increased obviously, when it is set as big, oscillation suppression effect would be weak.

Hd.02	Oscillation Suppression Amplitude Limiting Value	0 ~ 10000	No	5000	√
-------	--	-----------	----	------	---

Ascended value of large voltage during oscillation suppression could be limited through setting this parameter.

Hd.03	Oscillation Suppression Height Demarcation Frequency	0.00Hz ~ H0.04 (Maximum Frequency)	No	12.50Hz	√
-------	--	------------------------------------	----	---------	---

Hd.03 is the demarcation point of function code Hd.00 and Hd.01.

P146 V. Function Parameter Description

Hd.04	Oscillation Suppression	0: Oscillation suppression is valid. 1: Oscillation suppression is invalid.	No	1	√
-------	-------------------------	--	----	---	---

0: Oscillation suppression is valid;

1: Oscillation suppression is invalid. Oscillation suppression function is aimed at VF control, current oscillation phenomenon would appear very often during no-load or under-load operation of ordinary motor, which could cause abnormal operation of motor, and even make converter over-current. Hd.04=0 would enable oscillation suppression function, oscillation of motor would be suppressed by converter per parameters of Hd.00 ~ Hd.03 function group.

Hd.05	PWM Option	0: PWM Model 1 1: PWM Model 2 2: PWM Model 3	No	0	×
-------	------------	---	----	---	---

0: PWM model 1, this model is normal PWM model, motor noise would be smaller when it is low frequency, and would be bigger when it is high frequency.

1: PWM model 2, operation noise of motor in this model is smaller, but temperature rise is higher, if this function is chosen, converter needs to be used by being derated.

2: PWM model 3, operation noise of motor in this model is bigger, but with better suppression effect to motor oscillation.

Hd.06	Torque Setting Method Option	0: Keyboard setting torque (Hd.07) (100% relative to H3.07 torque upper limit) 1: Analog quantity VIN setting torque (100% relative to H3.07 torque upper limit) 2: Analog quantity SIN setting torque. (100% relative to H3.07 torque upper limit) 3: Analog quantity VIN+SIN setting torque (100% relative to H3.07 torque upper limit) 4: Multistage torque setting (100% relative to H3.07 torque upper limit) 5: Telecommunication setting torque (100% relative to H3.07 torque upper limit)	No	0	√
Hd.07	Keyboard Setting Torque	-100.0% ~ 100.0%	No	0	√

When H0.00=2, torque control is valid. Torque would be output by converter per set torque command when being controlled by torque, output frequency rate is limited by upper limit frequency. When load speed is higher than set upper limit frequency, output frequency of converter would be limited, and output torque would be different from set torque. When being controlled by torque, torque that set by Hd.06 is torque command. When torque command is set by keyboard (Hd.06 is 0), torque command could be obtained by setting function code

V. Function Parameter Description P147

Hd.07. motor would reverse when torque is set as negative number. It could be switched between torque control and speed control multifunction input terminal. When setting torque of converter is larger than load torque, output frequency of converter would increase, and converter would always operate in upper limit frequency when it reaches upper limit frequency. When setting torque of converter is smaller than load torque, output frequency of converter would decrease, and converter would always operate in lower limit frequency when it reaches lower limit frequency. 100.0% set by Hd.07 is set corresponding to torque upper limit, which is H3.07, and torque setting value could be altered by adjusting Hd.06 and Hd.07. Notice: When there is shutdown command for torque control, it would switch to speed control automatically.

Hd.08	Upper Limit Frequency Setting Source Options	0: Keyboard setting upper limit frequency (H0.05) 1: Analog quantity VIN setting upper limit frequency (100% corresponds to maximum frequency) 2: Analog quantity SIN setting upper limit frequency (100% corresponds to maximum frequency) 3: Multistage setting upper limit frequency (100% corresponds to maximum frequency) 4: Telecommunication setting upper limit frequency (100% corresponds to maximum frequency)	No	0	√
-------	--	---	----	---	---

Multiple upper limit frequency given source choice could be realized through H3.08. Especially for torque control, output frequency of converter could be altered by changing upper limit frequency.

Hd.09	Current-Limiting Action Options	0: Current-limiting is valid all the time. 1: Current-limiting is invalid in constant speed	No	0	√
-------	---------------------------------	--	----	---	---

Automatically current-limiting function would be always valid under acceleration and deceleration condition, and output frequency could be changed during automatic current-limiting action. So automatic current-limiting function is not suitable to be used in situation that requires stable output frequency during constant speed operation. When automatic current-limiting is valid, owing to lower setting of current-limiting level, it would affect overload ability of converter.

5.2.15 Factory Parameters Region

This group is factory parameters group. Customer should not attempt to open parameters of this group, otherwise, abnormal operation or damage of converter would be caused.

VI . Options/Accessories

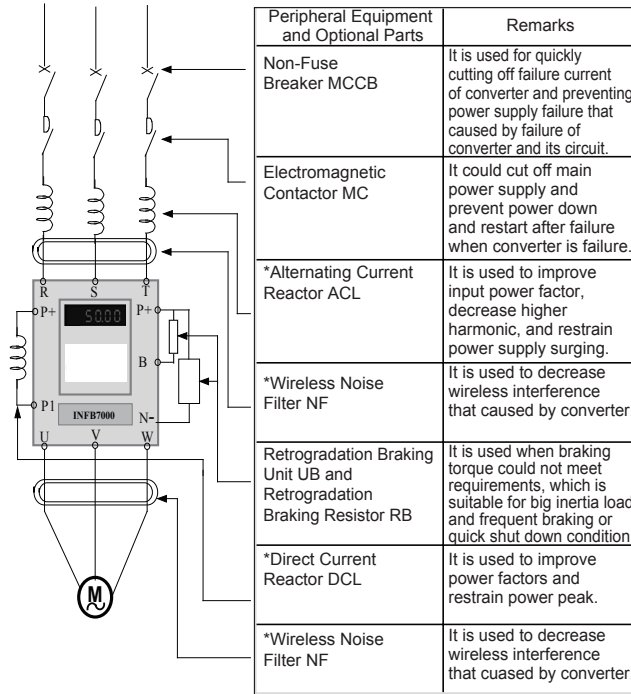

Figure 6-1 Connection Diagram of Peripheral Equipment and Optional Parts

Remarks!

- Those ones marked with "*" are optional parts.

Alternating Current Reactor ACL

Alternating current reactor could restrain higher harmonic of input current of converter, and improve power factors of converter obviously. It is suggested that

P150 VI . Options/Accessories

alternating current reactor should be adopted under following situations:

- Ratio of power supply capacity and converter capacity of the location that converter is used is more than 10:1. Silicon-controlled load or switch-controlled power factor compensation equipment is connected to the same power supply.
- Voltage unbalance of three-phase power supply is larger ($\geq 3\%$) .

Voltage (V)	Power (kW)	Current (A)	Inductance (mH)	Voltage (V)	Power (kW)	Current (A)	Inductance (mH)
220	0.4	2.4	4.6	380	0.75	2.5	7.6
	0.75	4.5	2.4		1.5	4	4.8
	1.5	7	1.6		2.2	6	3.2
	2.2	11	1.0		4	9	2.0
	4	18	0.6		5.5	13	1.5
	5.5	22	0.5		7.5	17	1.2
	7.5	30	0.4		11	25	0.8
	11	42	0.27		15	32	0.6
	15	55	0.2		18.5	38	0.5
	18.5	70	0.16		22	45	0.42
	22	80	0.14		30	60	0.32
	30	110	0.1		37	75	0.26
	37	145	0.08		45	90	0.21
	45	180	0.06		55	110	0.18
	55	215	0.05		75	150	0.13
	75	285	0.04		93	170	0.11
93	350	0.03	110	210	0.09		
110	415	0.03	132	250	0.08		

					160	300	0.06
					200	380	0.05
					220	415	0.05
					250	480	0.04
					280	520	0.04

Table 6-1 Alternating Current Reactor with Common Specifications

Direct Current Reactor DCL

- When power grid capacity is much larger than converter capacity or power supply capacity is larger than 1000KVA, or there are high requirements of improving power supply power factors, direct current reactor is needed to be mounted (shown as figure 8-1). Direct current reactor and alternating current reactor could be used at the same time, which could evidently affect on decreasing input higher harmonic.
- Converters of this series with more than 93 KW could be matched with direct current reactor. And converters with less than 75 KW could be required when being ordered so as to change P1 terminal accessories.

Voltage (V)	Power (KW)	Current (A)	Inductance (μ H)	Voltage (V)	Power (KW)	Current (A)	Inductance (μ H)
220	11 ~ 15	75	450	380	11 ~ 15	40	1500
	18.5 ~ 30	150	200		18.5 ~ 30	75	600
	37 ~ 55	300	100		37 ~ 55	150	300
	75 ~ 90	420	40		75 ~ 90	220	200
	110	560	25		110 ~ 132	280	140
					160 ~ 200	370	110
					220	560	70
					250 ~ 280	740	55

Table 6-2 Direct Current Reactor with Common Specifications

Wireless Noise Filter NF

Wireless noise filter is used for restraining conduction of electromagnetic interference noise that produced by converter, and also could suppress outside wireless interference and interference to this machine from instant impact and surge.

Voltage (V)	Motor Power (kW)	Voltage (V)	Motor Power (kW)	Filter Type	Major Parameters of Filter					
					Common-Mode Input Consumption dB			Differential-Mode Input Consumption dB		
					0.1 MHz	1 MHz	30 MHz	0.1 MHz	1 MHz	30 MHz
220	0.4 ~ 0.75	380	0.75 ~ 1.5	DL-5EBT1	75	85	55	55	80	60
	1.5 ~ 2.2		2.2 ~ 4	DL-10EBT1	70	85	55	45	80	60
	4 ~ 5.5		5.5 ~ 7.5	DL-20EBT1	70	85	55	45	80	60
	7.5		11 ~ 15	DL-35EBT1	70	85	50	40	80	60
	11 ~ 15		18.5 ~ 22	DL-50EBT1	65	85	50	40	80	50
	18.5 ~ 22		30 ~ 37	DL-80EBT1	50	75	45	60	80	50
	30		45	DL-100EBK1	50	70	50	60	80	50
	37		55 ~ 75	DL-150EBK1	50	70	50	60	70	50
	45 ~ 55		93 ~ 110	DL-200EBK1	50	70	60	60	70	50

Table 6-3 Common Three-Phase and Three-Wire System Wireless Noise Filter

With high requirements of preventing wireless interference and in occasion that needs to meet CE, UL, and CSA standards, or there is equipment without enough anti-interference ability around converter and other conditions, this filter should be used. Connecting wire should be shortened as possible when installed, and filter also needs to be installed closed to converter or inside of the machine (shown as figure 6-1)

Remote Operation Panel

There is operation panel that exquisitely designed and conveniently used on panel of converter of this series. Customer could purchase lengthened wire when operation panel needs to be led to other places that outside of the machine. Requirement needs to be offered only when ordering goods. Since serial communication method is adopted between operation panel and host computer, customer could remove operation panel to place that inside of 10m from host computer, if longer distance is needed, remote operation panel could be purchased from supplier or this company.

Retrogradation Braking Unit UB and Retrogradation Braking Resistor RB

The machines of this series with 11kW and below all should be internally installed with retrogradation braking function, if braking torque is needed to be added, only braking resistor is required to be connected externally. Machines above 15kW do not have this function, which need be connected externally with braking unit if braking torque is required to be added. When braking torque is 100%, resistance value and power

of braking resistor with common specification could be referred to following table:

Voltage (V)	Power of Motor (KW)	Resistance Value (W)	Power of Resistor (KW)	Voltage (V)	Power of Motor (KW)	Resistance Value (W)	Power of Resistor (KW)
220	0.75	200	0.1	380			
	1.5	100	0.25		1.5	400	0.25
	2.2	75	0.25		2.2	250	0.25
	4	40	0.4		4	150	0.4
	5.5	30	0.5		5.5	100	0.5
	7.5	20	0.8		7.5	75	0.8
	11	13.6	2.25		11	50	1
	15	10	3		15	40	1.5
	18.5	8	4		18.5	30	4
	22	6.8	4.5		22	30	4
	30	5	6		30	20	6
	37	5	6		37	16	9
	45	6.8/2	9		45	13.6	9
	55	6.8/2	9		55	20/2	12
	75	6.8/3	13.5		75	13.6/2	18
	90	6.8/3	13.5		90	20/3	18
	110	6.8/4	18		110	20/3	18
					132	20/4	24
					160	13.6/4	36
					200	13.6/5	45
					220	13.6/5	45
					250	13.6/6	54
					280	13.6/6	54

Table 6-4 Resistance Value and Power of Common Braking Resistor

Earth Leakage Protective Device

Since there is static capacitance to ground existed inside of converter, motor and input and output leading wire and converter of this series is low noise type whose carrier frequency is higher, thus earth leakage current of converter is higher, especially for machine with large capacity, sometimes even malfunction of protective circuit would be caused. When above questions happened, besides carrier frequency should be decreased properly and leading wire should be

shortened, earth leakage protective device should also be installed. The following questions should be paid attention to when earth leakage protective device is used:

- Earth leakage protective device should be installed on input side of converter, and it is more suitable to be installed behind MCCB (non-fuse breaker) (shown as figure 6-1).
- Action current of earth leakage protective device should be higher than 10 times of earth leakage current (total amount of earth leakage current of circuit, wireless noise filter and motor etc.) of this circuit that under working frequency power supply and without converter.

VII. Fault Inspection and Troubleshooting

7.1 Fault information and Troubleshooting

Fault Code	Fault type	Possible causes of fault	Solution
E001	U phase of INU failure	1. Acceleration is too fast 2. Interior of IGBT of the phase damaged 3. Malfunction caused by interference 4. If the grounding is good	1. Increase the acceleration time 2. Ask for help 3. Check the peripheral equipments for the strong source of interference
E002	V phase of INU failure		
E003	W phase of INU failure		
E004	Accelerate the overcurrent	1. Acceleration is too fast 2. Power grid voltage is low 3. Inverter power is low	1. Increase the acceleration time 2. Check input power supply 3. Choose another inverter with higher power of one level
E005	Decelerate the overcurrent	1. Deceleration is too fast 2. Load inertia torque is high 3. Inverter power is low	1. Increase the deceleration time 2. Add applicable dynamic braking module 3. Choose another inverter with higher power of one level
E006	Overcurrent at constant speed	1. Load abruptly changed or is abnormal 2. Power grid voltage is low 3. Inverter power is low	1. Check the load or decrease the abrupt change of load 2. Check input power supply 3. Choose another inverter with higher power of one level
E007	Accelerate the overvoltage	1. Input voltage is abnormal 2. After the moment power off, restart the motor which is still rotating	1. Check input power supply 2. Avoiding the restarting
E008	Decelerate the overvoltage	1. Deceleration is too fast 2. Load inertia is great 3. Input voltage is abnormal	1. Increase the deceleration time 2. Amplify the dynamic braking module 3. Check input power supply
E009	Overvoltage at constant speed	1. Input voltage changed abnormally 2. Load inertia is great	1. Install input reactor 2. Add applicable dynamic braking module

P156 VII. Fault Inspection and Troubleshooting

E010	Bus undervoltage	Power grid voltage is low	Check input power supply
E011	Motor overload	<ol style="list-style-type: none"> 1. Power grid voltage is low 2. The setting of motor rated current is incorrect 3. The motor is locked or the load abruptly changed 4. The motor is not applicable for low load. 	<ol style="list-style-type: none"> 1. Check power grid voltage 2. Reset the rated current of the motor 3. Check the load and adjust the torque lifting capacity 4. Choose an appropriate motor
E012	Converter overload	<ol style="list-style-type: none"> 1. Acceleration is too fast 2. Restart the motor which is still rotating 3. Power grid voltage is low 4. The load is heavy 	<ol style="list-style-type: none"> 1. Increase the deceleration time 2. Avoiding the restarting 3. Check power grid voltage 4. Choose another inverter with higher power
E013	Phaes failure of input side	Phase failure of inputs R、S、 T	<ol style="list-style-type: none"> 1. Check input power supply 2. Check installation wiring
E014	Phaes failure of output side	Phase failure of outputs U、 V、 W (or the three phases with load are seriously unsymmetrical.)	<ol style="list-style-type: none"> 1. Check output wiring 2. Check motor and cable
E015	Rectifier module overheating	<ol style="list-style-type: none"> 1. Frequency converter is instantaneous overcurrent. 2. The short circuit between three output phases or of the grounding. 3. The air channel is blocked or the fan is damaged. 4. The ambient temperature is too high. 5. The looseness of control board connection or plug-in unit 	<ol style="list-style-type: none"> 1. Refer to countermeasure for overcurrent. 2. Rewiring 3. Unblock the air channel or change the fan. 4. Reduce the ambient temperature. 5. Check and rewiring 6. Ask for service 7. Ask for service 8. Ask for service
E016	Inverting module overheating	<ol style="list-style-type: none"> 6. The auxiliary power supply is damaged, the driving voltage is undervoltage. 7. Power module bridge arm is pass through. 8. The control board is abnormal. 	

VII. Fault Inspection and Troubleshooting P157

E017	External fault	SI external fault input terminal acts	Check input of external equipment
E018	Communication fault	<ol style="list-style-type: none"> 1. The setting of Baud rate is not appropriate. 2. Communication fault of serial communication 3. The communication is interrupted for long time. 	<ol style="list-style-type: none"> 1. Set for appropriate Baud rate. 2. Press STOP/RST key for resetting, asking for help. 3. Check the wiring of communication interface
E019	Current detection electric circuit fault	<ol style="list-style-type: none"> 1. The connector of control board is not well connected. 2. Auxiliary power supply is damaged. 3. Hall device is damaged. 4. Amplifying circuit is abnormal. 	<ol style="list-style-type: none"> 1. Check connector and plug again. 2. Ask for service 3. Ask for service 4. Ask for service
E020	Motor self learning fault	<ol style="list-style-type: none"> 1. The capacity of motor does not match that of frequency converter. 2. The setting of motor rated parameter is improper. 3. The deviation of self learning parameter and standard parameter is great. 4. The self learning is overtime. 	<ol style="list-style-type: none"> 1. Change the frequency converter type. 2. Set rated parameter as per motor nameplate. 3. Make the motor no load and identify again. 4. Check the motor wiring and set parameter
E021	EEPROM read-write fault	<ol style="list-style-type: none"> 1. Control parameters' read-write is wrong. 2. EEPROM is damaged. 	<ol style="list-style-type: none"> 1. Press STOP/RST key for resetting, asking for help. 2. Ask for service
E022	PID feedback disconnection fault	<ol style="list-style-type: none"> 1. PID feedback is disconnected. 2. PID feedback source is disappeared. 	<ol style="list-style-type: none"> 1. Check signal line of PID feedback. 2. Check PID feedback source.
E023	Braking unit fault	<ol style="list-style-type: none"> 1. The braking line is fault or the brake pipe is damaged. 2. The resistance value of external brake resistor is low. 	<ol style="list-style-type: none"> 1. Check braking unit and change a new brake pipe. 2. Increase the resistance value of brake resistor.

7.2 Common faults and handling

The following problems may be encountered during the use of converters. Please refer to the following methods to analyse the simple faults.

No display when power on

Check whether the input power of the converter is in with the rated voltage of the converter by using a multimeter. If something's wrong with the power supply, please check and solve it. Check whether the three phase rectifier bridge is in good condition. If it has been exploded, please ask for service.

Check whether CHARGE light is on. If not, the fault is generally caused by the rectifier bridge or the buffer resistance. If it is on, the problem may be caused by the switch power and please ask for service.

After power on, the power air-break switch is tripped off: check whether the input power is grounding or short circuited and solve the problem. Check whether the rectifier bridge is broken down, if damaged please ask for service.

The motor does not rotate after the operation of the frequency converter

Check whether there exists balanced three phase output between U、V、W. If there exists, it may be caused by the motor line or self-damage otherwise the motor may be stuck because of mechanical reason and please solve it. If there exists output but not balanced, it may be caused by the damaged frequency converter drive board or output module and please ask for service. If no output voltage exists, it may be caused by the damaged drive board or output module and please ask for service.

The frequency converter displays normally after power on, but the power air-break switch trips off after the operation: check whether short circuit exists between output modules. If so please ask for service.

Check whether short circuit or grounding exists between motor leads. If so please solve it.

If tripping occurs occasionally and the distance between the motor and the frequency converter is relatively long, an output AC reactor is suggested to be furnished.

VIII . Communication Protocol

H5000 series converter with RS485 communication interface adopts international standard ModBus communication protocol to conduct Master–slave communication. Users can use PC/PLC and control upper computer and so on to implement centralized control (the setting of frequency converter control command, operation frequency, the modification of parameter for relevant function codes, the monitoring of frequency converter operative mode and fault information and so on) in order to satisfy the specific application needs.

8.1 Protocol content

The Modbus serial communication protocol defines the frame content and use format of asynchronous transmission for serial communication, which includes the format of master polling and broadcast frame and slave response frame. The frame content of master includes slave address (or the broadcast address), executive command, data and fault verification and so on. The response of the slave adopts the same structure which includes action confirmation, return data and fault verification and so on. If an error occurs when the slave is receiving a frame, or it can not implement the action required by the master, it will feed back a fault frame to the master as the response.

8.2 Application mode

H5000 series frequency converter is accessed by the control network of “several slaves based on one master” with RS232/RS485 bus.

8.3 Bus structure

(1) Interface mode

RS485 hardware interface

(2) Transmission mode

It is asynchronous serial, half–duplex transmission mode. At the same time between master and slave can only one send data while the other receive data. Data in serial asynchronous communication is sent frame by frame in the form of message.

(3) Topological structure

It is a system with one master and several slaves. The setting range of slave address

is from 1 to 247, and 0 is the broadcast communication address. Each slave address in the network is unique, which is the basis requirement for ModBus serial communication.

8.4 Protocol specification

H5000 series frequency converter's communication protocol is a kind of asynchronous serial of master-slave ModBus communication protocol. Only one of network equipment (master) is able to build a protocol (called "inquires/command"). Other equipment (slaves) can only response master's "inquires/command" by providing data or make the corresponding action according to master's "inquires/command". The master herein is referred to the personal computer (PC), industrial control equipment or programmable logic controller (PLC) and so on, while the slave is referred to H5000 series frequency converter or other control equipment with the same communication protocol. The master not only can communicate with a certain slave separately, but also can send the broadcast message to all the slaves. As for the master "inquires/command", the slave needs to send back a message (called response), while as for the broadcast message sent by the master, the slave does not need to feed back the response to the master.

8.5 Communication frame structure

H5000 series frequency converter's ModBus protocol for communication data format is divided into two communications RTU (remote terminal units) mode and ASCII (American Standard Code for Information International Interchange) mode.

In RTU mode, each byte format is as follows:

Coding system: 8 bit binary
Hexadecimal 0 ~ 9、A ~ F

Each frame field of eight bits includes two hex characters.

In ASCII mode, each byte format is as follows:

Coding system: communication protocol belongs to the hexadecimal, character meanings of ASCII information:

"0"... "9","A"... "F" each hexadecimal stands for each ASCII information, for example

Character	'0'	'1'	'2'	'3'	'4'	'5'	'6'	'7'	'8'	'9'
ASCII CODE	0x30	0x31	0x32	0x33	0x34	0x35	0x36	0x37	0x38	0x39
Character	'A'	'B'	'C'	'D'	'E'	'F'				
ASCII CODE	0x41	0x42	0x43	0x44	0x45	0x46				

Byte bit:

Including the starting bit, 7 or 8 data bits, parity bit and stop bit.

The description of byte bit is as follows:

11-bit character frame:

Starting bit	Bit1	Bit2	Bit3	Bit4	Bit5	Bit6	Bit7	Bit8	No Parity Bit Even parity check Odd parity check	stop bit
--------------	------	------	------	------	------	------	------	------	--	----------

10-bit character frame:

Starting bit	Bit1	Bit2	Bit3	Bit4	Bit5	Bit6	Bit7	No Parity Bit Even parity check Odd parity check	stop bit
--------------	------	------	------	------	------	------	------	--	----------

In RTU mode, the new one is always in the time of at least 3.5 byte transmission for waiting as start. In the network of calculating transmission rate by Baud rate, it is easy to ensure the transmission time of 3.5 byte. Following the transmission data field is in sequence: slave address, operating command code, data and CRC check word, and each transmission byte of field is always hexadecimal 0...9, A...F. The network equipment always monitor the action of the communication bus, even in the interval of waiting. When the first field is received (address message), each network equipment makes confirmation for the byte. When the last byte transmission is finished, there will be an interval of 3.5 byte transmission, which indicates the finish of the frame. After that, a new frame transmission will start.

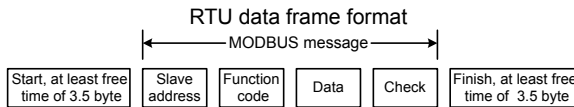

A frame information must be transmitted continuously in the form of data stream. If there is an interval of more than 1.5 byte transmission time before the whole frame transmission finished, the receiving equipment will erase these incomplete information and regard the following byte as the address field of the new frame. In the same way, if the interval is less than the transmission time of 3.5 byte between the starting of a new frame and the finishing of the previous one, the receiving equipment will regard it as the continuation of the previous one. As the disorder of the frame, CRC check value is incorrect, which leads to communication failure.

Standard structure of RTU frame

FH(frame header) START	T1-T2-T3-T4 (transmission time of 3.5 byte)
Slave address field ADDR	Communication address: 0 ~ 247 (decimalism) (0 is broadcast address)
Function field CMD	03H: read slave parameter 06H: write slave parameter
Data field DATA (N-1) ... DATA (0)	2*N byte data, this part is the main content of the communicaiton as well as the core of the data exchange.
CRC CHK Lo	Test value: CRC check value (16BIT)
CRC CHK Hi	
Frame end END	T1-T2-T3-T4 (transmission time of 3.5 byte)

In ASCII mode, the start is “ : ” (“0x3A”), and the end is defaulted as “CRLF” (“0x0D” 0x0A”). In ASCII mode, expect the start and the end, all the rest data bytes will be transmitted in the form of ASCII code, sending the high 4 bytes first and then the low 4 bytes. In ASCII mode, the data is 7 or 8 bits. As for ‘A’ ~ ‘F’ , their capital letters of ASCII code will be used. At this moment, the data adopts LRC check, including the information from slave address to data. Check sum is equal to the complement of character sum of all the check data involved (abandon carry bit).

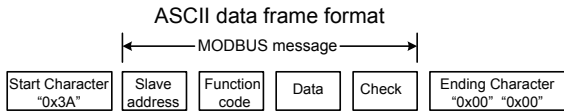

Standard structure of ASCII frame

START	“ : ” (0x3A)
Address Hi	Communication address: 8-bit address consists of 2 ASCII codes
Address Lo	
Function Hi	Function code: 8-bit address consists of 2 ASCII codes
Function Lo	
DATA (N-1) ... DATA (0)	Data content: nx8-bit data content consists of 2n ASCII codes n<=16, at most 32 ASCII codes
LRC CHK Lo	LRC check code: 8-bit check code consists of 2 ASCII codes
LRC CHK Hi	
END Hi	Ending character: END Hi=CR (0x0D) , END Lo=LF (0x0A)
END Lo	

8.6 Description of command code and communication data

For example: the slave address of the frequency converter is 01H, and initial address of the memory is 0004, and read 2 continuous words, the description of the frame is as follows:

RTU master command information

START	T1-T2-T3-T4 (transmission time of 3.5 byte)
ADDR	01H
CMD	03H
Initial address Hi	00H
Initial address Lo	04H
Data number Hi	00H
Data number Lo	02H
CRC CHK Lo	85H
CRC CHK Hi	CAH
END	T1-T2-T3-T4 (transmission time of 3.5 byte)

RTU slave response information

START	T1-T2-T3-T4 (transmission time of 3.5 byte)
ADDR	01H
CMD	03H
Byte number	04H
Data address 0004H Hi	00H
Data address 0004H Lo	00H
Data address 0005H Hi	00H
Data address 0005H Lo	00H
CRC CHK Lo	43H
CRC CHK Hi	07H
END	T1-T2-T3-T4 (transmission time of 3.5 byte)

ASCII master command information

START	‘:’
ADDR	‘0’
	‘1’

CMD	'0'
	'3'
Initial address Hi	'0'
	'0'
Initial address Lo	'0'
	'4'
Data number Hi	'0'
	'0'
Data number Lo	'0'
	'2'
LRC CHK Lo	'F'
LRC CHK Hi	'6'
END Lo	CR
END Hi	LF

ASCII slave response information

START	','
ADDR	'0'
	'1'
CMD	'0'
	'3'
Byte number	'0'
	'4'
Data address 0004H Hi	'0'
	'0'
Data address 0004H Lo	'0'
	'2'
Data address 0005H Hi	'0'
	'0'
Data address 0005H Lo	'0'
	'0'
LRC CHK Hi	'F'
LRC CHK Lo	'6'
END Lo	CR
END Hi	LF

8.6.2 Command code: 06H (0000 0110), write a word

For example: write 5000 (1388H) to the address of 0008H of frequency converter slave address 02H. The description of the frame structure is as follows:

RTU master command information

START	T1-T2-T3-T4 (transmission time of 3.5 byte)
ADDR	02H
CMD	06H
Write data address Hi	00H
Write data address Lo	08H
Data content Hi	13H
Data content Lo	88H
CRC CHK Lo	05H
CRC CHK 高位 CRC CHK Hi	6DH
END	T1-T2-T3-T4 (transmission time of 3.5 byte)

RTU slave response information

START	T1-T2-T3-T4 (transmission time of 3.5 byte)
ADDR	02H
CMD	06H
Write data address Hi	00H
Write data address Lo	08H
Data content Hi	13H
Data content Lo	88H
CRC CHK Lo	05H
CRC CHK Hi	6DH
END	T1-T2-T3-T4 (transmission time of 3.5 byte)

ASCII master command information

START	‘.’
ADDR	‘0’
	‘2’
CMD	‘0’
	‘6’
Write data address Hi	‘0’
	‘0’
Write data address Lo	‘0’
	‘8’
Data content Hi	‘1’
	‘3’
Data content Lo	‘8’
	‘8’
LRC CHK Hi	‘5’
LRC CHK Lo	‘5’
END Lo	CR
END Hi	LF

ASCII slave response information

START	‘.’
ADDR	‘0’
	‘2’
CMD	‘0’
	‘6’
Write data address Hi	‘0’
	‘0’
Write data address Lo	‘0’
	‘8’
Data content Hi	‘1’
	‘3’
Data content Lo	‘8’
	‘8’
LRC CHK Hi	‘5’
LRC CHK Lo	‘5’
END Lo	CR
END Hi	LF

8.6.3 Communication frame error check mode

The error check mode of frame mainly consists of two parts that is bit check of byte (odd/even check) and the whole data check of frame (CRC check and LRC check).

8.6.3.1 Byte bit check

Users can choose the mode of bit check according to different needs or choose no check, which will affect the setting of byte check bit.

The meaning of even parity checking: before data transmission add an even parity bit, used to show the number of "1" is odd or even in the data transmission. If it is even, set the check bit to "0", otherwise set to "1" to keep the data parity remains the same.

The meaning of odd parity checking: before data transmission add an odd parity bit, used to show the number of "1" is odd or even in the data transmission. If it is odd, set the check bit to "0", otherwise set to "1" to keep the data parity remains the same.

For example, when it is need to transfer the "11001110" which contains five "1", if use even check, its even parity bit is "1", if use odd check, the odd parity bit is "0".

During the data transmission, the parity bit is set on the position of frame check bit after the calculation. The receiving equipment also makes parity check, and if the data parity accepted does not agree with preset, it regards the communication is incorrect.

8.6.3.2 CRC check mode

RTU frame format used includes the frame error check field based on the method of calculating the CRC. CRC field checks the whole frame content. CRC field consists of two bytes, including 16 bit binary values. It is added to the frame after the calculation of transmission equipment. The receiving equipment recalculates the frame CRC received, and compare it with the value of CRC field received. If the two CRC values are not equal, the transmission have mistakes.

CRC first stores 0 xFFFF and then process continuous six or more bytes of frame and the current value of the register. Only 8Bit data of the character is effective for CRC, and starting and stop bits and parity check bit are invalid.

During CRC produce process, each 8 bit characters with register contents XOR separately. The results move to the least significant bit (LSB), and the most significant bit (MSB) is filled with 0. LSB is extracted for check, and if LSB is 1, the register and preset value is XOR separately, if LSB is 0, it's not. The process shall repeat 8 times. After the completion of the last bit (the eighth bit), and the next 8 bit character and the current value of the register XOR. Finally register value is the CRC value after all the bytes of frame implemented.

The calculation method of the CRC adopts the international standard of the

CRC check algorithm. When users edit CRC algorithm, he can refer to relevant standard CRC algorithm and write a CRC calculation program which truly meets the requirements.

Now a simple function of the CRC calculation is provided for user's reference (using C programming language):

```
unsigned int crc_cal_value(unsigned char *data_value,unsigned char data_
length)
{
int i;
unsigned int crc_value=0xffff;
while(data_length--)
{
crc_value^=*data_value++;
for(i=0;i<8;i++)
{
if(crc_value&0x0001)crc_value=(crc_value>>1)^0xa001;
else crc_value=crc_value>>1;
}
}
return(crc_value);
}
```

In ladder logic, CKSM calculates CRC value according to the frame content, using look-up table calculation method. The program of this method is simple with high operation speed, but the program that takes up comparatively large ROM space. Therefore please carefully use it if there is limitation for the program space.

8.6.3.3 ASCII check mode (LRC Check)

Check code (LRC Check) is the sum from Address to Data Content. For example as above mentioned in 11.6.2, the check code of communication information: $0x02 + 0x06 + 0x00 + 0x08 + 0x13 + 0x88 = 0xAB$, and then take complement for 2 = $0x55$.

The definition of communication data address

This part is the definition of communication data address, which is used to control the operation of the frequency converter, get the converter status information and set relevant function parameters and so on.

(1) Express rules of parameter address for function code

Parameters in function code sequence numbers correspond to register address. But if you want to convert it into hex, such as the sequence number of H5.05 is 58, then use hex to express the function code address that is 003 AH.

The range of high and low byte is: high byte-00 ~ 01; low byte-00 ~ FF.

Note: HE group is factory set parameters which can neither read or changed; when the frequency converter is running some parameters can not be changed; some parameters can not be changed under any circumstances of frequency converter state; when you change the function code parameters, please pay attention to parameters' setting range, the unit, and related instructions.

In addition, because EEPROM is frequently being stored, it will reduce the service life of EEPROM. For the users, some function codes in communication mode does not to be stored, instead only the value of RAM needs to be changed that can satisfy the requirements of operation. To realize the function, as long as the MSB of corresponding function code address is changed from 0 to 1. For example: if the function code H0.07 is not to be stored into EEPROM and only the value of RAM needs to be changed, the address can be set to 800 CH. This address can only be used for writing RAM, but can not be used as the function of read, otherwise it is invalid address.

(2) Address description of other functions:

Function description	Address definition	Data significance	R/W feature
Communication control command	1000H	0001H : forward operation	W/R
		0002H : reversal operation	
		0003H : forward inching	
		0004H : reversal inching	
		0005H : stop	
		0006H : free stop (emergency stop)	
		0007H : fault resetting	
		0008H : inching stop	
Frequency converter mode	1001H	0001H : in forward operation	R
		0002H : in reversal operation	
		0003H : frequency converter standby	
		0004H : in trouble	

Communication setting address	2000H	Communication setting value range (-10000 ~ 10000) Note: the set value of communication is the percentage of relative value (100.00% ~ 100.00%), which can be used for communication write operation. When it is set as frequency source, the relative is the percentage of maximum frequency (H0.04); When it is as PID given or feedback, the relative is the percentage of PID. Thereinto, the PID given value and PID feedback value are in the form of percentage of PID calculation.	W/R
Description of run/stop parameter address	3000H	operation frequency	R
	3001H	setting frequency	R
	3002H	bus voltage	R
	3003H	output voltage	R
	3004H	output current	R
	3005H	operation rotate speed	R
	3006H	output power	R
	3007H	output torque	R
	3008H	PID given value	R
	3009H	PID feedback value	R
	300AH	terminal input flag state	R
	300BH	terminal output flag state	R
	300CH	analog variable AI1 value	R
	300DH	analog variable AI2 value	R
	300EH	reserved	R
	300FH	reserved	R
	3010H	reserved	R
3011H	reserved	R	
3012H	current segment of multi-speed	R	

Frequency converter fault address	5000H	The serial number of fault type in fault information code and function code menu are consistent. Only are the hexadecimal data returned to the upper computer here but not fault characters.	R
ModBus communication fault address	5001H	0000H : fault free 0001H : password incorrect 0002H : command code incorrect 0003H : CRC check incorrect 0004H : illegal address 0005H : illegal data 0006H : parameter change invalid 0007H : system locked 0008H : frequency converter occupied (EEPROM in storing)	R

8.6.5 The extra response of communication error

When the frequency converter communication is connected, if an error occurs, this time the frequency converter will respond to error code and response to master control system in a fixed format, letting master control system know that there are errors. No matter the communication command code of frequency converter is "03" or "6", the command byte of fault response for frequency converter is always "06", and data address is fixed for 0x5001.

For example:

RTU slave fault response information

START	T1-T2-T3-T4 (transmission time of 3.5 byte)
ADDR	01H
CMD	06H
Fault return address Hi	50H
Fault return address Lo	01H
Fault code Hi	00H
Fault code Lo	05H
CRC CHK Lo	09H
CRC CHK Hi	09H
END	T1-T2-T3-T4 (transmission time of 3.5 byte)

ASCII slave fault response information

START	‘:’
ADDR	‘0’
	‘1’
CMD	‘0’
	‘6’
Fault return address Hi	‘5’
	‘0’
Fault return address Lo	‘0’
	‘1’
Fault code Hi	‘0’
	‘0’
Fault code Lo	‘0’
	‘5’
LRC CHK Hi	‘A’
LRC CHK Lo	‘3’
END Lo	CR
END Hi	LF

The meaning of fault code

False code of	Explain
1	command code incorrect
2	command code incorrect
3	CRC check incorrect
4	illegal address
5	illegal data
6	parameter change invalid
7	system locked
8	frequency converter occupied (EEPROM in storing)